

Panasonic

Color CCTV Camera Operating Instructions

Model No. **WV-NS324**

ENGLISH

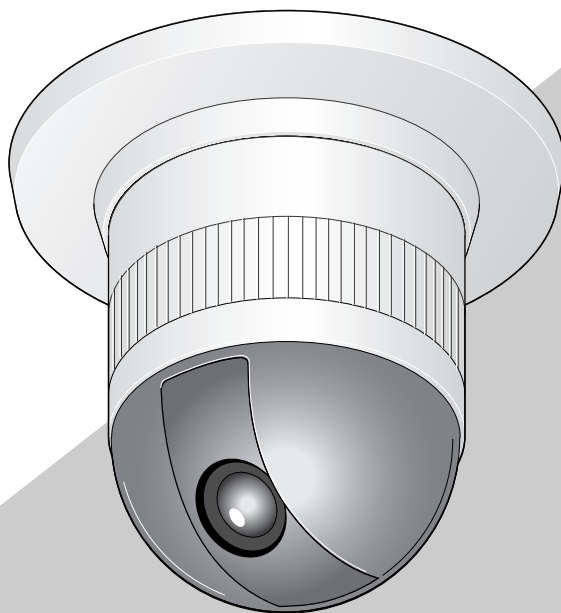

FRANÇAIS

Before attempting to connect or operate this product,
please read these instructions carefully and save this manual for future use.

ENGLISH VERSION

	CAUTION RISK OF ELECTRIC SHOCK DO NOT OPEN	
CAUTION: TO REDUCE THE RISK OF ELECTRIC SHOCK, DO NOT REMOVE COVER (OR BACK). NO USER SERVICEABLE PARTS INSIDE. REFER SERVICING TO QUALIFIED SERVICE PERSONNEL.		

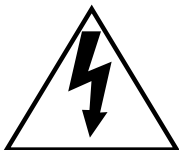

SA 1965

The lightning flash with arrowhead symbol, within an equilateral triangle, is intended to alert the user to the presence of uninsulated "dangerous voltage" within the product's enclosure that may be of sufficient magnitude to constitute a risk of electric shock to persons.



SA 1966

The exclamation point within an equilateral triangle is intended to alert the user to the presence of important operating and maintenance (servicing) instructions in the literature accompanying the appliance.

For U.S.A

Warning:

This equipment generates and uses radio frequency energy and if not installed and used properly, i.e., in strict accordance with the instruction manual, may cause harmful interference to radio communications. It has been tested and found to comply with the limits for a Class A computing device pursuant to Subpart J of Part 15 of FCC Rules, which are designed to provide reasonable protection against such interference when operated in a commercial environment.

The serial number of this product may be found on the top of the unit.

You should note the serial number of this unit in the space provided and retain this book as a permanent record of your purchase to aid identification in the event of theft.

Model No. WV-NS324

Serial No. _____

WARNING: To prevent fire or electric shock hazard, do not expose this appliance to rain or moisture. The apparatus shall not be exposed to dripping or splashing and that no objects filled with liquids, such as vases, shall be placed on the apparatus.

IMPORTANT SAFETY INSTRUCTIONS

- 1) Read these instructions.
- 2) Keep these instructions.
- 3) Heed all warnings.
- 4) Follow all instructions.
- 5) Do not use this apparatus near water.
- 6) Clean only with dry cloth.
- 7) Do not block any ventilation openings. Install in accordance with the manufacturer's instructions.
- 8) Do not use near any heat sources such as radiators, heat registers, stoves, or other apparatus (including amplifiers) that produce heat.
- 9) Do not defeat the safety purpose of the polarized or grounding-type plug. A polarized plug has two blades with one wider than the other. A grounding-type plug has two blades and a third grounding prong. The wide blade or the third prong are provided for your safety. If the provided plug does not fit into your outlet, consult an electrician for replacement of the obsolete outlet.
- 10) Protect the power cord from being walked on or pinched particularly at plugs, convenience receptacles and the points where they exit from the apparatus.
- 11) Only use attachments/accessories specified by the manufacturer.
- 12) Use only with the cart, stand, tripod, bracket, or table specified by the manufacturer, or sold with the apparatus. When a cart is used, use caution when moving the cart/apparatus combination to avoid injury from tip-overs.



- 13) Unplug this apparatus during lightning storms or when unused for long periods of time.
- 14) Refer all servicing to qualified service personnel. Servicing is required when the apparatus has been damaged in any way, such as power-supply cord or plug is damaged, liquid has been spilled or objects fallen into the apparatus, the apparatus has been exposed to rain or moisture, does not operate normally, or has been dropped.

CONTENTS

IMPORTANT SAFETY INSTRUCTIONS	3
PREFACE	6
Features	6
System Requirements	6
Trademarks	6
Document Convention	7
■ Camera Cleaning	7
■ Preset Data Uploading or Downloading	7
PRECAUTIONS	8
CONSTRUCTION	9
INSTALLATION	10
CONNECTIONS	13
SETUP WITH PC	16
■ Setup with the Provided "Panasonic IP Setup" Software	16
PREPARATIONS FOR THE PC	17
■ Network Setup of Your PC	17
■ Network Setup of the Camera	18
OPERATING THE CAMERA	21
SETUP	22
■ Setup Menu	22
SETTING PROCEDURES	25
■ Menu Display	25
■ Presetting	25
■ Deleting Preset Positions	28
■ Home Position Setting (HOME POSITION)	29
■ Self-return Setting (SELF RETURN)	29
■ Auto Mode Selection (AUTO MODE)	29
■ Flip-A-Chip Setting	31
■ Cleaning (CLEANING)	31
■ Image Hold (IMAGE HOLD)	31
■ Camera Setting	32
INITIALIZING	40
Setting the Switches	40
Common procedures:	40
TROUBLESHOOTING	41
SPECIFICATIONS	42
PREVENTION OF BLOOMING AND SMEAR	42
ACCESSORIES	43
OPTIONAL ACCESSORIES	43
APPENDIX	44

PREFACE

Panasonic introduces a newly developed dome camera with highly advanced CCTV technology for connection to both conventional surveillance systems and digital networks. Color camera, zoom lens, pan and tilt mechanism are all combined in a single compact unit.

This high-performance color CCTV camera is utilized as a video surveillance device.

It incorporates a Digital Signal Processor, pan-tilt mechanism, and x10 zoom lens in a compact enclosure.

A newly developed 1/4-inch CCD allows use under extremely low lighting conditions of 1.0 lx for color images.

Thanks to the use of the DSP it also assures clear display of pictures in which bright and dark objects coexist without mutual interference. Setup menus allow the camera to fulfill surveillance tasks by such means as flip-a-chip and auto pan.

Features

- 10/100BASE-T terminal enables your PC to view camera images via the network.
- Multiscreen function for simultaneous display of the pictures of up to 4 cameras on the PC monitor screen.
- Multishot function allows you to see surroundings of the object with clicking one time.
- User authentication function is available.
- High quality picture of 768 x 494 pixels
- Minimum illumination of 1.0 lx
- Flip-a-chip allows 180° tilting to trace objects passing under the camera.
- Auto pan
- BLC
- SENS UP X4 (MAX)
- MOTION DETECTOR
- 16 preset positions
- 360° panning at a rotation speed of 100°/s
- Sync selectable between internal, line-lock or VD2
- Automatic gain control circuit
- Image hold
- Digital noise reduction effect

System Requirements

Your personal computer must meet the following minimum requirements to view camera pictures or to set up parameters.

Computer: PC/AT compatible

OS: One of the following should be installed.
Microsoft Windows98 Second Edition
Microsoft Windows2000 Professional Service Pack2
Microsoft Windows Millennium Edition
Microsoft Windows XP
Microsoft Windows NT Workstation 4.0 Service Pack6a

CPU: Pentium II (300 MHz) or faster

Memories: 128 MB or higher

Network Interface: 10/100Mbps Ethernet card

Applicable Network Protocols: TCP/IP, UDP/IP, HTTP, FTP, SMTP, DNS, DDNS, DHCP, ARP, BOOTP, NTP

Browser: One of the following should be installed.
Internet Explorer 5.01SP2, 5.5, 5.5SP2, 6.0
Netscape Communicator 4.73, 4.78

Caution under the circumstances of Netscape Communicator except version 4.73 and 4.78

It may happen some of the functions work wrongly when using the Netscape Communicator version 4.73 before, or upgraded version 4.73.

Then, take the following procedures on your PC:

1. Take notes all the setting status of Netscape Communicator in advance.
2. Uninstall the old Netscape Communicator and delete the holder named Netscape from your PC once.
3. Install the applicable version of Netscape Communicator to your PC.
4. Input the same setting status that item 1 to the Netscape Communicator.

Trademarks

- Adobe, Adobe logos, and Acrobat are registered trademarks of Adobe Systems Incorporated in the U.S. and/or other countries.
- Microsoft, Windows, Windows NT, and Windows XP are registered trademarks of Microsoft Corporation in the U.S. and/or other countries.
- Netscape, Netscape Navigator, Netscape ONE, the Netscape N and Ship's Wheel logos are registered trademarks of Netscape Communications Corporation in the U.S. and other countries. Other Netscape product names used in this document are also trademarks of Netscape Communications Corporation and may be registered outside the U.S.
- Ethernet is a registered trademark of Xerox Corporation.
- Other names of companies and products contained in these operating instructions may be trademarks or registered trademarks of their respective owners.

- Distributing, copying, disassembling, reverse compiling, reverse engineering, and also exporting in violation of export laws of the software provided with this product, is expressly prohibited.

Document Convention

These operating instructions use the following conventions when describing the uses and operations.

- Windows98 stands for Microsoft Windows98 Second Edition.
- Windows2000 stands for Microsoft Windows2000.
- Windows ME stands for Microsoft Windows Millennium Edition.
- Windows NT stands for Microsoft Windows NT Workstation 4.0 Service Pack6a.
- Windows XP stands for Microsoft Windows XP.

■ Camera Cleaning

Even if this function is used, noise may be produced on the monitor screen, or the preset position may deviate in the cause of prolonged use.

In such cases, activate the refresh mode on the special menu. (See page 39.)

To use this camera with the WJ-SX550C Matrix Switcher, set the auto cleaning function on each unit, then clean the WV-NS324 once a day.

■ Preset Data Uploading or Downloading

To download the preset data from the camera to the controller or upload the downloaded data to the camera, set the following functions to OFF.

Downloading or uploading the data may not work normally if these functions are set to ON.

- Cleaning (See page 31.)
- Auto mode (See page 29.)
- Self return (See page 29.)

Aim the camera at a motionless object such as a wall if possible to download or upload the preset data.

Note: Take notice of the following cases when uploading the downloaded data to the camera.

- Preset positions may deviate. If a preset position has deviated, delete it and set it again correctly.
- You cannot exchange preset data between the WV-NS324 and other models.
- Data uploading or downloading is applicable with Panasonic System Controller only.

PRECAUTIONS

1. Do not attempt to disassemble the camera.

To prevent electric shock, do not remove screws or covers.

There are no user-serviceable parts inside.

Ask a qualified service personnel for servicing.

2. Handle the camera with care.

Do not abuse the camera. Avoid striking, shaking, etc. The camera could be damaged by improper handling or storage.

3. Do not expose the camera to rain or moisture, nor try to operate it in wet areas.

This product is designed for indoor use or locations where it is protected from rain and moisture. Moisture can damage the camera and also cause electric shock.

If the camera becomes wet, turn the power off immediately and ask a qualified service personnel for servicing.

4. Do not use strong or abrasive detergents when cleaning the camera body.

Use a dry cloth to clean the camera when it is dirty. When the dirt is hard to remove, use a mild detergent and wipe gently. Care should be taken not to scratch the dome cover when wiping it.

Wipe off any remaining detergent in it with a dry cloth.

5. Never face the camera towards the sun.

Whether the camera is in use or not, never aim it at the sun or other extremely bright objects. Otherwise, blooming or smear may be caused.

6. Never aim the camera at strong light sources for an extended period of time.

A light source such as a spot light causes burn-in on the display screen. Failure to observe this may cause the image to become discolored due to deterioration of the color filter in the CCD.

7. Do not install this camera upside down.

This camera is designed for mounting on the ceiling or wall.

Consult an expert on the load bearing capacity of the installation surface and structure. If the surface is not strong enough, the camera may fall down. Refer to the product specifications for weights.

8. Do not operate the camera beyond the specified temperature, humidity or power source ratings.

Do not use the camera in an extreme environment where high temperature or high humidity exists. Do not place the camera near heat sources such as radiators, stoves or other units that produce heat.

Use the camera under conditions where temperatures are between -10°C and $+50^{\circ}\text{C}$ (14°F to 122°F) [Recommended temperature: $+40^{\circ}\text{C}$ (104°F)], and humidity is below 90 %.

The input power source is 24 V AC 60 Hz.

9. Do not install the camera near the air outlet of an air conditioner.

The lens may become cloudy due to condensation if the camera is used under the following conditions.

- Rapid temperature fluctuations by switching the air conditioner on and off.
- Rapid temperature fluctuations due to frequent opening and closing of a door.
- Use in an environment where eyeglasses become foggy.
- Use in a room filled with cigarette smoke or dust.

If the lens becomes cloudy due to condensation, remove the dome cover and wipe all moist surfaces with a soft cloth.

10. Consumables

Parts having contacts such as the lens-drive motors, cooling fan motor and slip-rings inside the camera are subject to wear with time. Please ask the nearest service centre about replacement and maintenance of such parts.

11. Do not aim the camera at the same object for a long time.

Burn-in of an image may be caused on the fluorescent screen of the CRT.

- Matsushita Electric Industrial Co., Ltd. herewith declares that it will not be liable for any damage, whether direct or indirect, caused by using the product for business transactions or security, or malfunctioning of this product.

12. Self-diagnosis Function

If the camera continues operating abnormally for 30 seconds or more due to influences such as external noise, the camera will automatically restart. In the event that this happens frequently, check for any causes in the camera's environment.

CONSTRUCTION

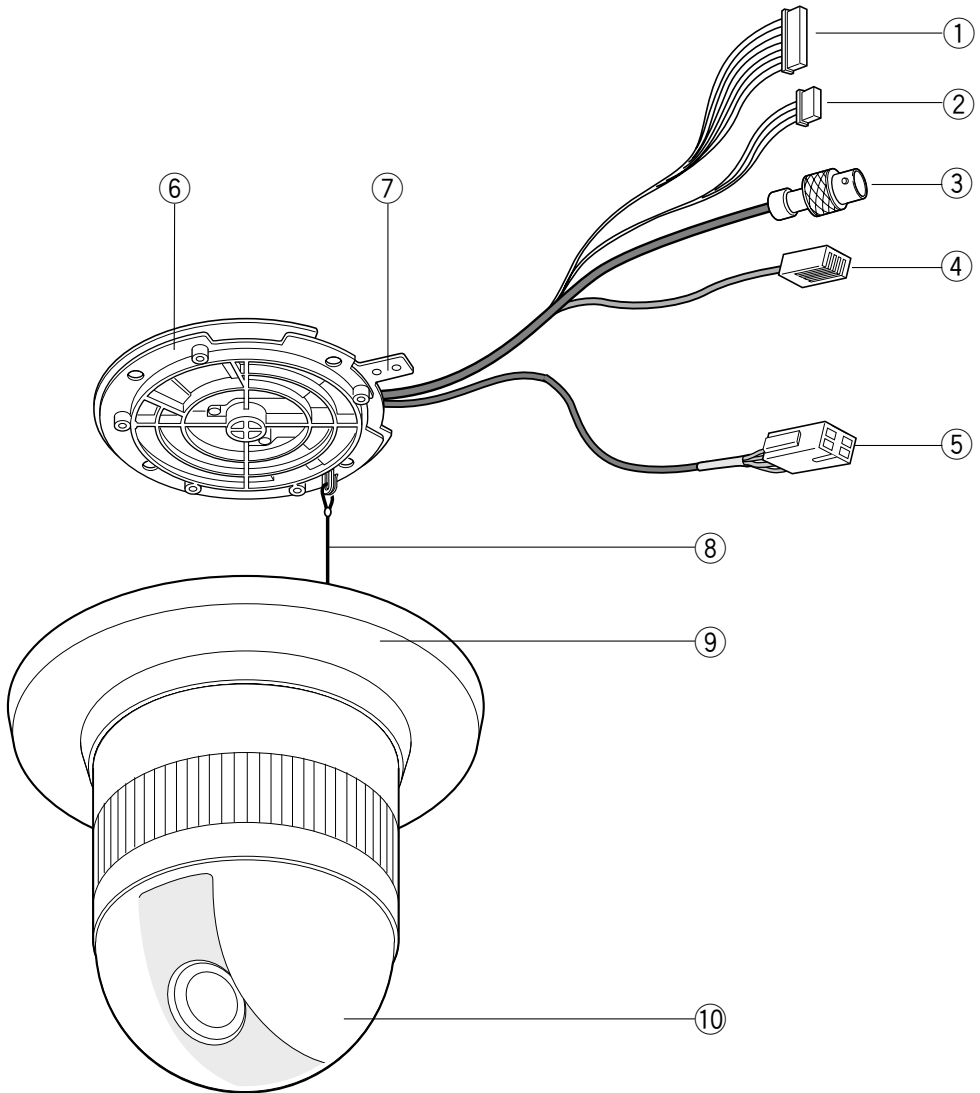

① Alarm Input Connector

② Alarm Output Connector

③ Video Output Connector

④ Network Port

⑤ Power Cable

⑥ Camera Mounting Base (Color: Gray)

⑦ Panning Starting Point

⑧ Fall Prevention Wire

⑨ Decoration Cover

⑩ Dome Cover

INSTALLATION

Precautions

- The following installation and connection work should be done by qualified service personnel or system installers and should conform to all local codes.
- Be sure to switch the camera off before installation and connection.
- Do not install the camera near the air outlet of an air conditioner.

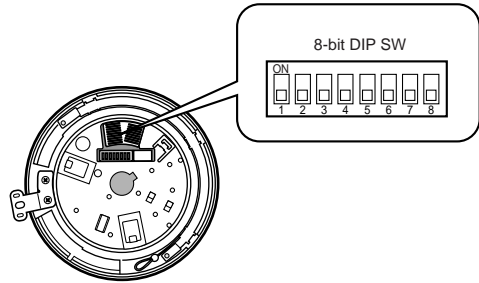

1. Disassembling the Camera

- (1) Loosen the fixing screw to separate the camera mounting base from the camera. Push up the screwdriver once before removing the screw.
- (2) Turn the camera mounting base approximately 15 degrees counterclockwise and remove the base from the camera.

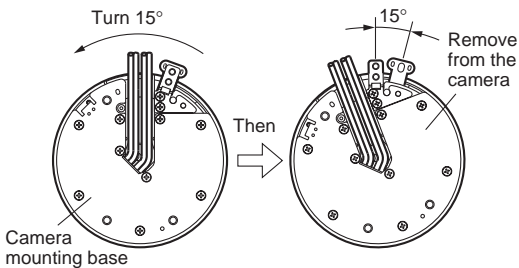
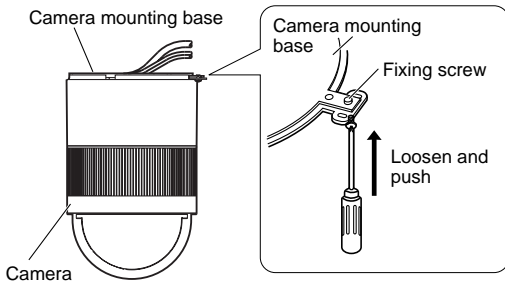

2. Setting Switches

The camera is provided with an 8-bit DIP switch. The 8-bit DIP switch is used to return the camera to the factory default settings. Switch settings are read into the camera when the power is turned on. Make sure to turn the camera off, then turn it back on after changing the switch settings. Switch positions and functions are shown below.

Note: When taking these procedures, keep the power turned on until initialization of the Camera Servo Control is completed.

No.	DIP SW1	DIP SW2	Status	Dip SW Position
1	OFF	OFF	Normal	
2	ON	OFF	Initializing the setup menu	
3	OFF	ON	Initializing HTML files	
4	ON	ON	Initializing the setup menu & HTML files	

Note: All DIP switches except SW1 and SW2 should always be set to "off".

3. Assemble the Camera

Reverse the disassembly procedure. Take care not to cut any cables.

Precaution

Be sure to select a ceiling board strong enough to support 4 times the total weight of the camera.

a. Sideway Cable Exit

Prepare a cutout in the diecast case and decoration cover as shown in the following figures.

Cutout in Diecast Case

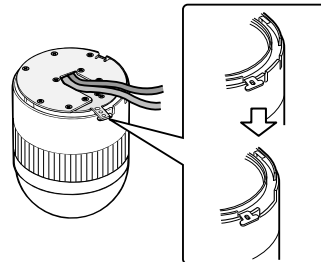

Cutout in Decoration Cover

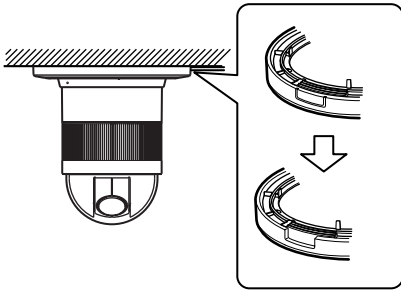

Note: Remove sharp edges to protect the cables.

b. Top Cable Exit

Prepare a hole in the ceiling board to run the cables.

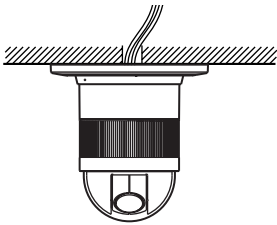

1. Mark the mounting holes on the ceiling, using the removed camera mounting base as a template.

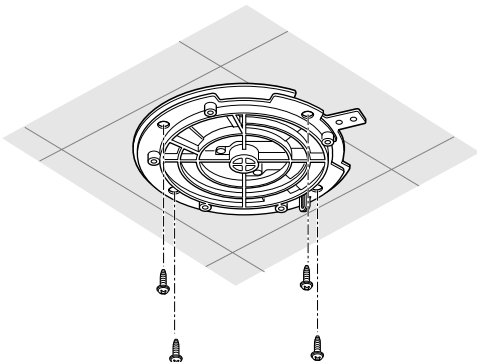
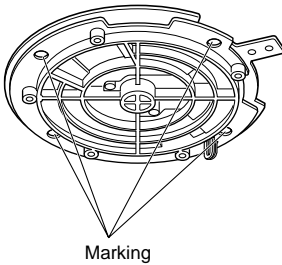

2. Fix the camera mounting base to the ceiling with four screws (not provided, M4).
3. Hook the fall prevention wire on the camera mounting base.

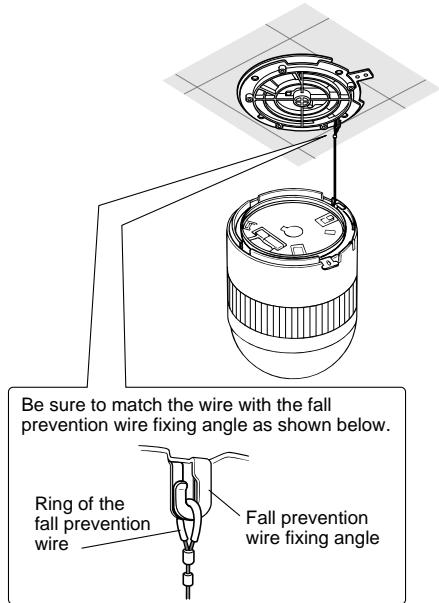

Cautions:

- Use the supplied dust protection sheet if the camera mounting base is liable to be exposed to a dusty atmosphere. Remove the cover from the dust protection sheet, then stick the sheet on the camera mounting base.
 - Remove the sheet before mounting the camera on the base.
 - While the camera is separated from the base, keep the camera in the supplied polyethylene sack.
4. Mount the camera on the camera mounting base and rotate the camera clockwise.

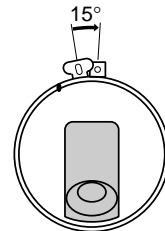

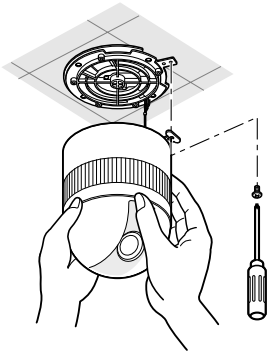

5. Tighten the fixing screw M3 (provided).

Notes:

- (1) Tighten the camera fixing screw with a screwdriver.
- (2) Follow the instructions given here to ensure that the camera and camera mounting base are installed safely.
- (3) When removing the camera from the camera mounting base, loosen and press up the camera fixing screw (M3) by using a screwdriver.

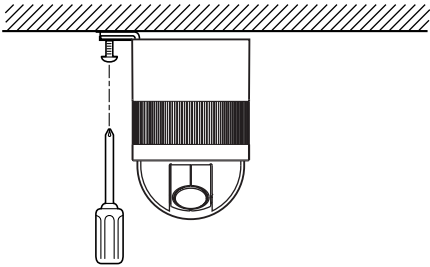

6. Fix the decoration cover to the camera mounting base.

a. Sideway Cable Exit

Pass the cables through the cutout made in the diecast case and decoration cover.

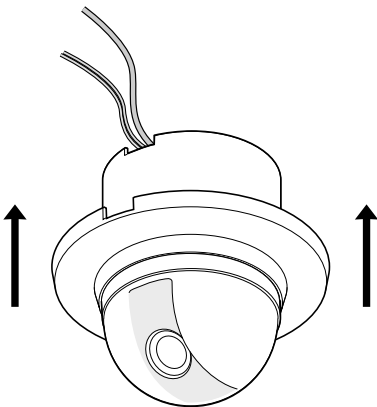

b. Top Cable Exit

Push the decoration cover against the camera mounting base.

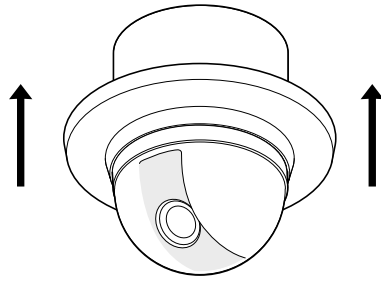

CONNECTIONS

Precautions

- The following connections should be made by qualified service personnel or system installers in accordance with all local codes.
- See the reverse side of the cover page for mains lead connection.

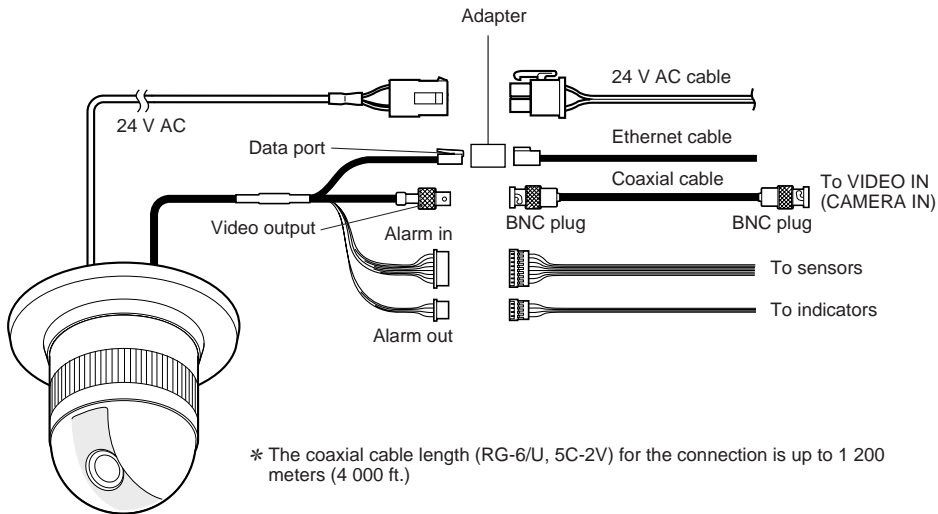

* The coaxial cable length (RG-6/U, 5C-2V) for the connection is up to 1 200 meters (4 000 ft.)

Note: When powered up, the unit performs a self-check (including one panning, tilting, zooming and focusing operation).

• 24 V AC Power Supply Connection

Recommended wire gauge sizes for 24 V AC line

Copper wire size (AWG)		#24 (0.22mm ²)	#22 (0.33mm ²)	#20 (0.52mm ²)	#18 (0.83mm ²)
Length of cable (approx.)	(m)	20	30	45	75
	(ft)	65	100	160	260

Accessory Connector Information

Pin no.	Power source
1	24 V AC LIVE
2	24 V AC NEUTRAL
3	Ground
4	Not use

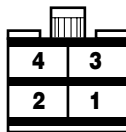

Prepare the individual conductors for clamping. Use MOLEX band tool part number 57027-5000 (for UL-Style Cable UL1015) or 57026-5000 (for UL-Style UL1007) for clamping the contacts.

After clamping the contacts, push them into the proper holes in the accessory connector of this camera until they snap in place.

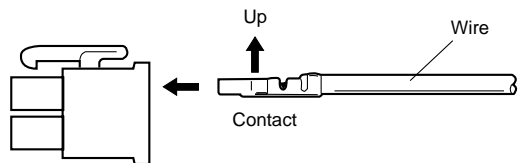

Cautions:

- Shrinking the cable-entry seal is a one-time procedure. Do not shrink the cable-entry seal until it has been ascertained that the unit is functioning.
- CONNECT THIS TO 24V AC CLASS 2 POWER SUPPLY ONLY.

How to Assemble the Cable with the Accessory Connector

Strip back the cable jacket approx. 3 mm (0.1 inch) and separate the individual conductors.

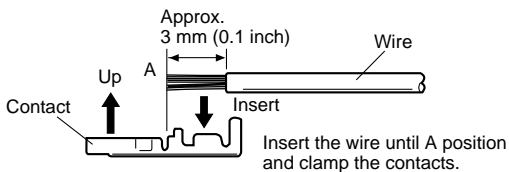

• **Ethernet Connection**

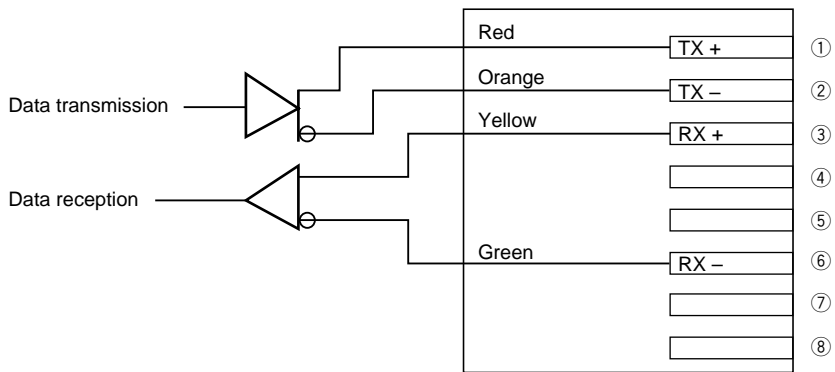

• **ALARM IN Connections**

An 8-pin and a 4-pin harness are supplied with the camera as standard accessories. Connect external sensors to this connector. Input specifications are low-active, non-voltage contact (ON when active) or open collector (Low when active). The table below shows wire colors versus pin functions.

Alarm IN (8-pin)

Wire Color	Function
Black	IN 1
Brown	GND
Red	IN 2
Orange	GND
Yellow	GND
Light Blue or Green	GND
Blue	GND
Purple	GND

• **ALARM OUT/AUX OUT Connections**

Connect an external device, for example, a buzzer or lamp, to this connector. Output specifications are low-active, open-collector and a drive capacity of 16 V DC 100 mA maximum. The table below shows wire colors versus pin functions.

Note: Use a relay if the voltage or current of the connected device exceeds the ratings.

Alarm OUT/AUX OUT (4-pin)

Wire Color	Function
Gray	Alarm OUT
White	GND
Pink	AUX OUT
Yellow Green or Light Blue	GND

• **Video Cable Connections**

The maximum extensible coaxial cable length between the camera and the monitor is shown in the table.

Type of coaxial cable		RG-59/U (3C-2V)	RG-6/U (5C-2V)	RG-11/U (7C-2V)	RG-15/U (10C-2V)
Recommended maximum cable length	(m)	250	500	600	800
	(ft)	825	1 650	1 980	2 640

Network Connections

Prior to connections, specify the connection type and prepare relevant devices and cables.

Notes:

- We recommend that you use connection type 1 or 2 when setting up the network address of the camera.
- Be sure to unplug or switch off all the devices before starting connections.

• **Direct Connection to PC (Type 1)**

Use a category 5 cross-type network cable to connect the camera directly with the PC.

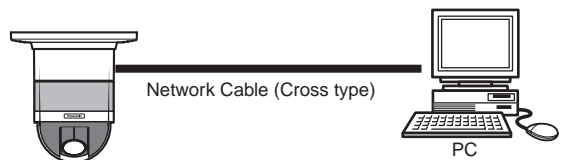

Necessaries: Cross-type network cable (Category 5)

• Connection to Intranet (Type 2)

A switching hub connected to the intranet is placed between the camera and the PC.

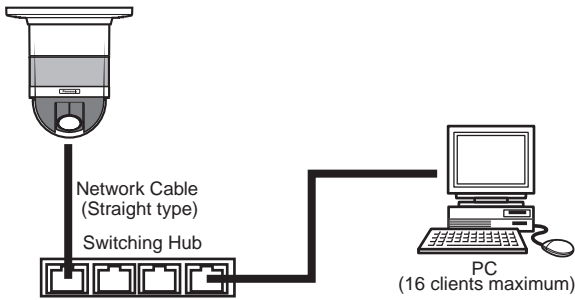

Necessaries:

- Straight-type network cable (Category 5)
- Switching hub or router (for 10BASE-T/100BASE-TX)

Necessaries:

- Straight-type network cable (Category 5)
- CATV modem (cable modem) or DSL modem
- Switching hub or router (for 10BASE-T/100BASE-TX)

Notes:

- Setting the router is required when connecting more than one camera. Refer to the manual included with the router.
- The camera does not support PPPoE. Use a router that handles PPPoE when connecting the camera using that protocol.
- A global-type IP address is required when connecting via the Internet.

• Connection to Internet (Type 3)

The PC accesses the camera through the Internet and the DSL/CATV modem.

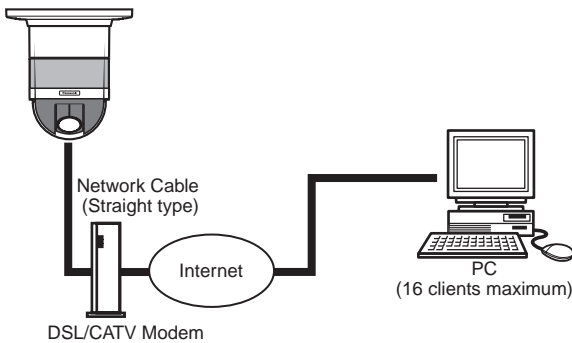

Necessaries:

- Straight-type network cable (Category 5)
- CATV modem (cable modem) or DSL modem

• Connection to Internet (Type 4)

A switching hub or a router may be added to a type 3 connection.

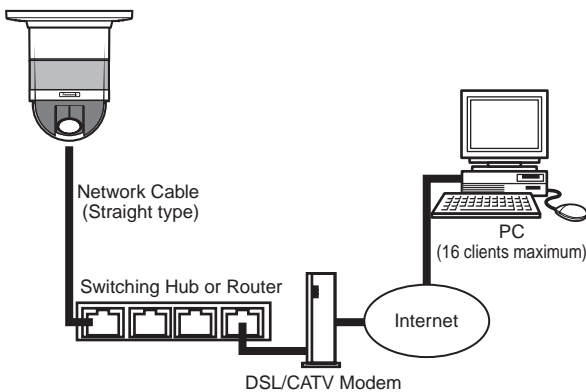

SETUP WITH PC

Notes:

- Do not access this menu through HTML or controllers during the Panasonic IP Setup procedure.
- Only one administrator is required.

■ Setup with the Provided "Panasonic IP Setup" Software

Set up the network of the camera using the "Panasonic IP Setup" software included on the CD-ROM provided with the camera.

Note: If a firewall (including software) exists, allow access to all UDP ports. Otherwise, it is impossible to use the "Panasonic IP Setup" software.

In the English folder included in the Setup folder, double-click IP setup.exe.

The "Panasonic IP Setup" starts up.

The MAC address and the IP address of the connected camera will be displayed. (Click the [REFRESH] button if they are not displayed.)

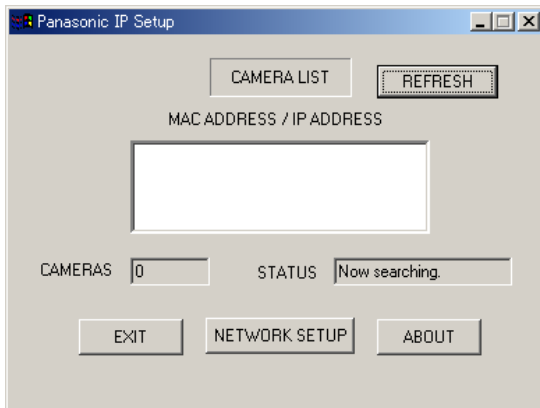

1. Click the MAC address/IP address of the camera to be set up.
2. Click the [NETWORK SETUP] button.

Notes:

- When two or more cameras are connected, the MAC addresses and the IP addresses of all the connected cameras will be displayed.
- The "Panasonic IP Setup" software can recognize only those cameras in the same subnet.
- Pressing the [REFRESH] button will display the updated MAC addresses and IP addresses of all the connected cameras that are in the same subnet.

The setup window appears.

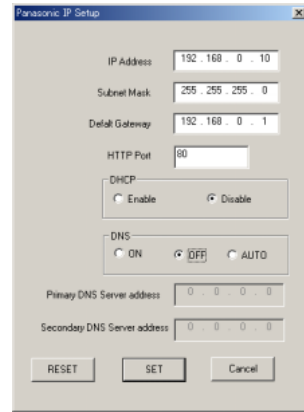

3. Set parameters for each item.
"IP Address"
"Subnet Mask"
"Default Gateway"
"HTTP Port"
4. Input the parameters for your environment.
"DHCP"
"DNS"
5. Click the [Enable] button when using DHCP and DNS.
When using the DHCP and DNS functions, enter the "Primary DNS Server address" and the "Secondary DNS Server address".
6. Click [AUTO] when the DNS server gets primary and secondary IP addresses from the DHCP server.

Notes:

- If DHCP is enabled although there is no DHCP server in the network, check "Disable" for DHCP in the "Panasonic IP Setup" window.
- If DHCP is enabled, and the DHCP server has not assigned an IP address yet, "0.0.0.0" is displayed for the IP address. The IP address of the camera will be displayed after the DHCP server assigns one to the camera.

7. Click the [SET] button after completing the setting.

Important: It takes around 10 seconds for settings to take effect after the [SET] button has been pressed. The settings may be performed incorrectly if the power is off or the Ethernet cable is detached before the settings are completed.

Note: Do not make any other settings while executing Panasonic IP Setup.

PREPARATIONS FOR THE PC

■ Network Setup of Your PC

To set up the network of the PC, first change the TCP/IP settings of the PC to match them to the default settings of the camera.

The following are the default network settings of the camera.

IP address : 192.168.0.10
Subnet mask : 255.255.255.0
Default gateway : 192.168.0.1

To access the camera, the IP address of the PC should be "192.168.0.XXX" (where XXX should be a number from 2 to 254 except 10).

Note: The procedure described below is based on the assumption that Windows XP is running on the PC. When running an OS other than Windows XP, see the manual included with the OS.

1. Start up your PC.
2. Click the [Start] button and select "Control Panel".

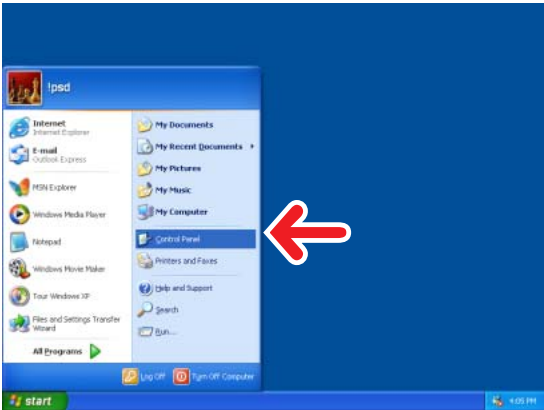

3. Double-click the "Network and Internet Connections" icon.

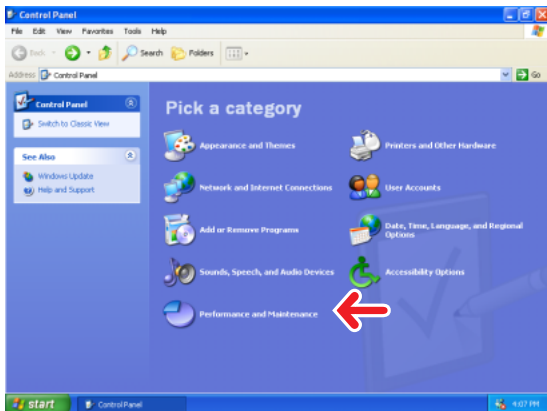

4. Double-click the "Network Connections" icon.

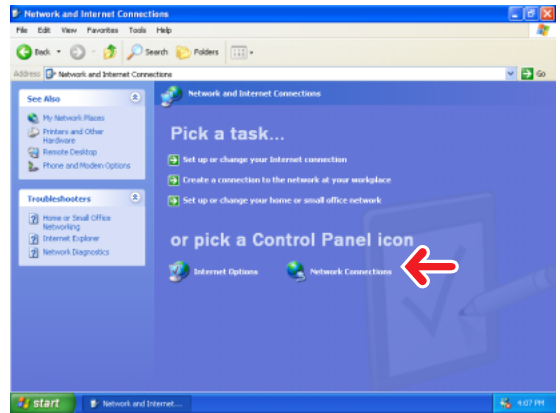

5. Click "Local Area Connection 2", and then click "Change settings of this connection" in the "Network Tasks" menu.

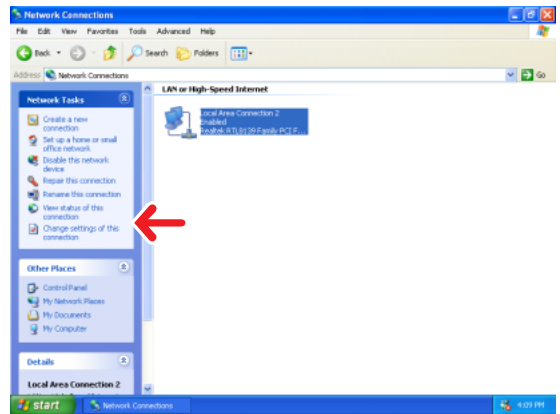

6. Click "Internet Protocol (TCP/IP)", and then click the [Properties] button.

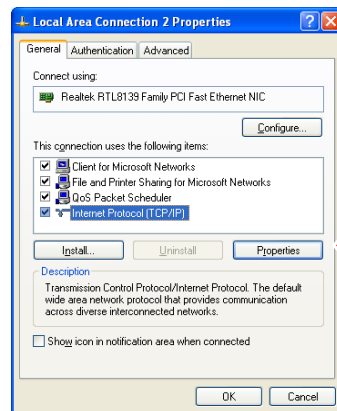

- Click the "Use the following IP address" radio button and enter the IP address and the subnet mask as follows.

IP address : 192.168.0.9
Subnet mask : 255.255.255.0

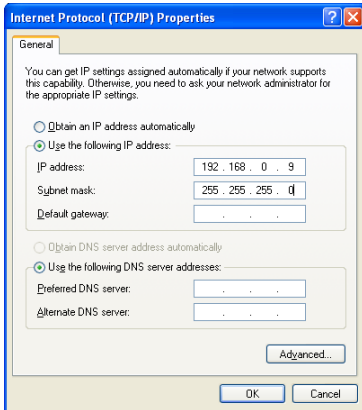

- Click the [OK] button, and the window dialog box closes.

Note: Use a small sized picture when a blue picture appears instead of the live picture due to Internet traffic congestion.

■ Network Setup of the Camera

On completion of the network setup of the PC, begin the network setup of the camera. If two or more cameras are connected, each camera needs to be set up individually. The following information is necessary for the network setup of the camera. If you do not have this information, contact your network administrator or Internet service provider.

- IP address
- Subnet mask
- Default gateway (when using a gateway server or a router)
- Port number
- DNS server address 1 and/or 2 (when using DNS)

- Start up Internet Explorer on your PC.
- Enter "http://192.168.0.10" (the default IP address of the camera) in the address bar. The main page of the camera appears.

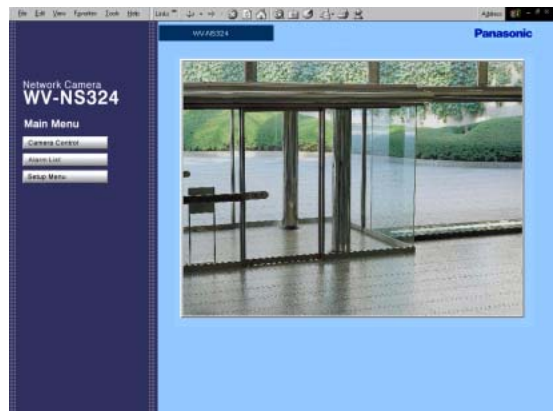

3. Click the [Setup Menu] button. The "User administration" window appears.



- Enter "admin" in the user line.
Note: The default setting is "admin". The administrator should change the user name and password in the User Setting Menu.

4. Click the [OK] button. The "Setup Menu" window appears.



5. Click the [Network] button. The "Network Setup" window appears.

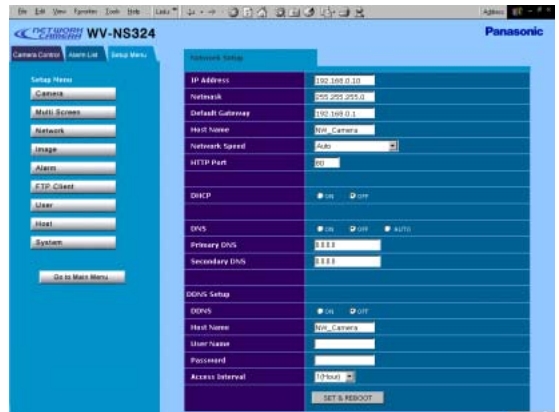

6. Enter parameters for each item in the columns. The parameters differ depending on the connection type.

Preliminary Setup

Prior to connection to the system, you need to set up a network address for the camera by one-to-one connection with a PC.

The factory default parameters are as follows:

IP address: 192.168.0.10
Subnet mask: 255.255.255.0
Gateway: 192.168.0.1
HTTP port number: 80

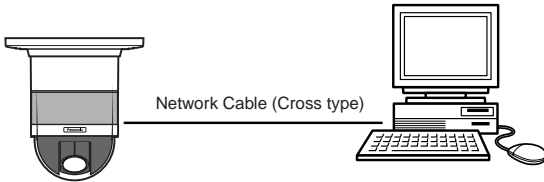

1. Enter an IP address, "http://192.168.0.10" for example, in the address bar of the browser to display the main page of the WV-NS324 camera.
2. Click the [Setup Menu] button. The authentication dialog appears.

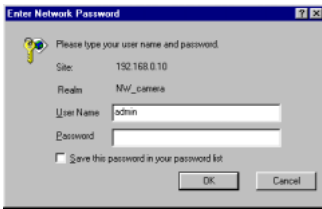

3. Enter "admin" in the user name line. According to the default setting, you need not enter the password. The "Network Setup" window appears.

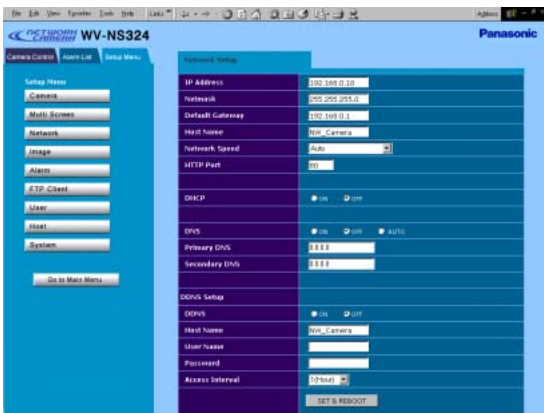

4. Set the following parameters.

Note: Ask your system administrator about parameters if you are unsure.

IP Address: Enter numbers 0 through 255 into four sections split by dots.

Netmask: Enter numbers 0 through 255 into four sections split by dots.

HTTP Port: Enter different numbers for each when multiple cameras are connected.

DHCP (Dynamic Host Configuration Protocol): When set to ON, you need not input the IP address and netmask.

DNS (Domain Name System): Set to ON when using DNS. Enter the primary address. If necessary, enter the secondary address.

When set to AUTO, the DHCP server will automatically send you an address.

DDNS (Dynamic DNS): Consult your system administrator.

Note: You can correct the DHCP setting to off via the Panasonic IP setting or Camera control menu if you have wrongly set DHCP to ON in a none-DHCP/DHCP server system.

For details refer to Setup included in the "Panasonic IP Setup" Software provided.

5. Click the [SET&REBOOT] button. The changed parameters will be validated, and the camera and the PC will restart.

Notes:

- Do not omit step 4 above to validate new parameters.
- Wait around 5 seconds or more when executing [SET&REBOOT] button.

6. Close the browser software, and the PC.

OPERATING THE CAMERA

• Function Comparison / PC Network vs. Camera site

Function	PC Network	Camera Site (*1)
VIEWING IMAGES		
PAN/TILT	A	A
ZOOM/FOCUS	A	A
IRIS	A	A
PRESET	A	A
AUTO PAN	A	A
360MAP	A	NA
AUX Device Control	A	NA
Alarm Log/Alarm Image Display	A	NA
MENU SETUPS		
Camera Setup (Camera)	A	A
Network Setup (Camera)	A	A
Network Setup (HTML)	A	NA
Operating Mode Setup (HTML)	A	NA
Alarm Setup (HTML)	A	NA
FTP Client Setup (HTML)	A	NA
User Authentication (HTML)	A	NA
Host Authentication (HTML)	A	NA
System Setup (HTML)	A	NA

A: Available, NA: Not Available

Note:

*1 The setup menus are operated from a system device, e.g., a Video Multiplexer or a system controller. The side panel buttons on the camera can be used as well.

■ Setup Menu

Setup menus are shown in the diagram below. These enable you to adapt the camera to your own requirements. The menus are described on the following pages for reference prior to setup. Switches, keys and the joystick are used for setup operations.

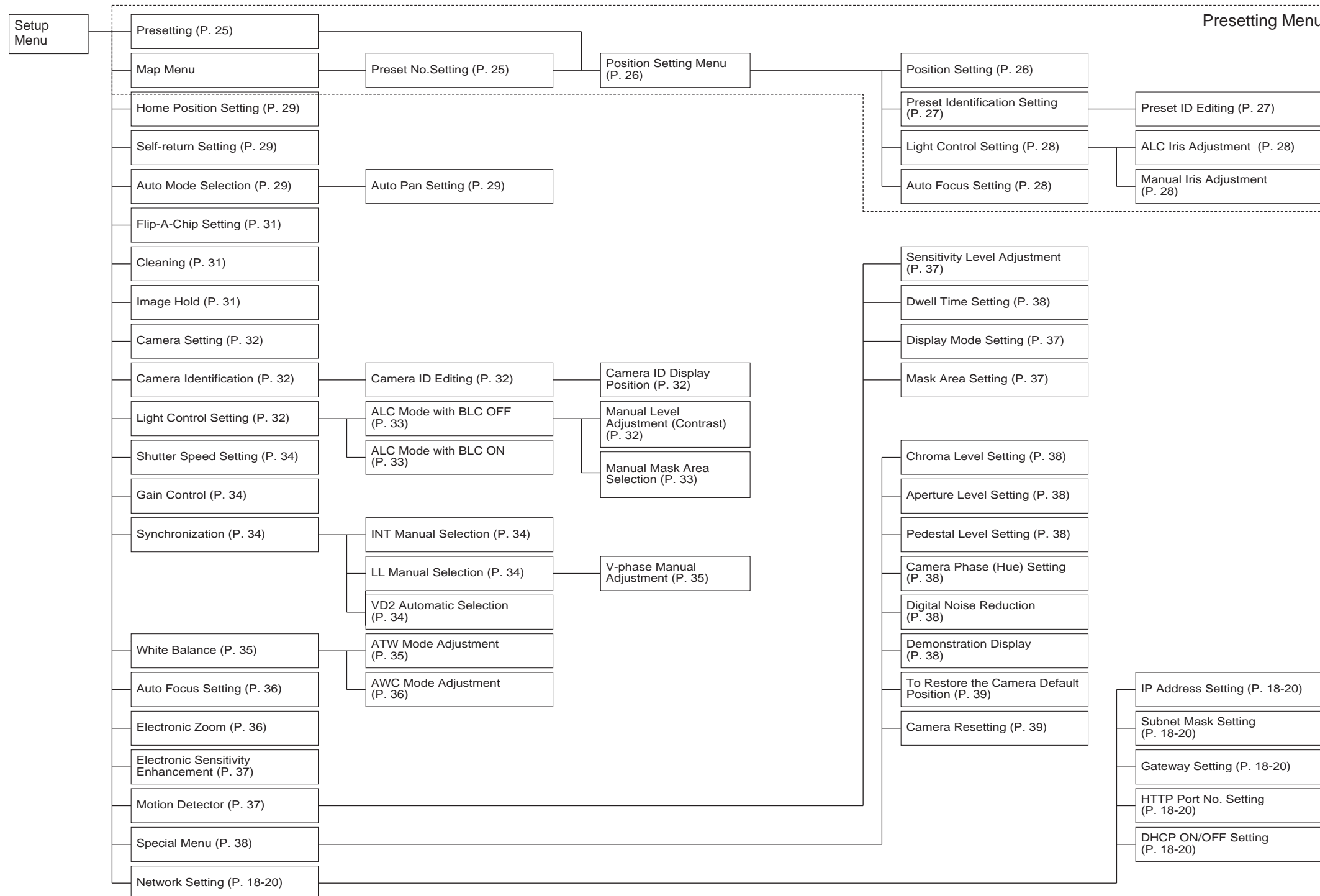

[WV-CU550CJ]

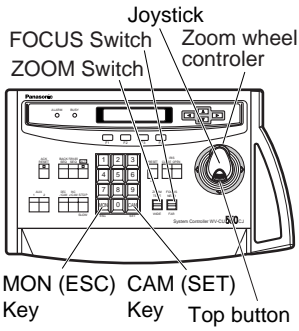

[WV-CU360CJ]

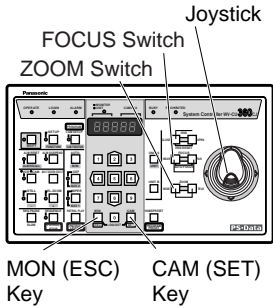

[WV-CU161C]

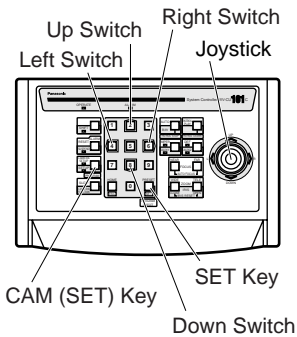

[WV-RM70]

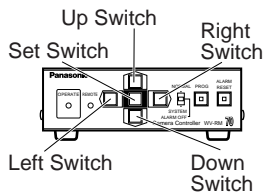

Function/Controller	WV-CU550CJ	WV-CU360C	WV-CU161C	WV-RM70
Open CAM SETUP	See page 25	CAM SETUP key (for 2 seconds or more)	CAMERA SETUP key (for 2 seconds or more)	PROG SW (for 2 seconds or more) and SET SW at CAMERA SETUP on Program Menu
Close CAM SETUP	F4 key	CAM SETUP key (for 2 seconds or more)	CAMERA SETUP key (for 2 seconds or more)	PROG SW
Move the cursor	Joystick (←, ↑, ↓, →)	Joystick (←, ↑, ↓, →)	Direction SW (←, ↑, ↓, →)	Direction SW (←, ↑, ↓, →)
Select a parameter	Joystick (←, →)	Joystick (←, →)	Direction SW (←, →)	Direction SW (←, →)
Adjust the level	Joystick (←, →)	Joystick (←, →)	Direction SW (←, →)	Direction SW (←, →)
Move the camera direction	Joystick (←, ↑, ↓, →)	Joystick (←, ↑, ↓, →)	Joystick (←, ↑, ↓, →)	Direction SW (←, ↑, ↓, →)
Zoom & Focus	ZOOM SW & FOCUS SW or Zoom wheel controller & Top button	ZOOM SW & FOCUS SW	ZOOM SW & FOCUS SW	Direction SW (←, ↑, ↓, →)
Enter the setting	CAM (SET) key	CAM (SET) key	CAM (SET) key	SET SW
Open a submenu	CAM (SET) key	CAM (SET) key	CAM (SET) key	SET SW
Enter CAM ID & PRESET ID display position	MON (ESC) key	MON (ESC) key	MON (ESC) key	SET SW (for 2 seconds or more)
Enter MASK setting	MON (ESC) key	MON (ESC) key	MON (ESC) key	SET SW (for 2 seconds or more)
All Reset	F3 key	4+5+6 key (for 2 seconds or more)	4+5+6 key (for 2 seconds or more)	R+SET+L SW (for 2 seconds or more)
Open Special	F2 key	4+6 key (for 2 seconds or more)	4+6 key (for 2 seconds or more)	R+L SW (for 2 seconds or more)

SETTING PROCEDURES

The following setting procedures are described on the assumption that this model is used in combination with the WJ-SX550C Matrix Switcher and WV-CU550CJ System Controller. In case a controller other than the WV-CU550CJ is used, refer to the table on page 24.

■ Menu Display

● Setup Menu Display

WV-CU550CJ

1. Select the camera number you want to set up and a monitor to display the SET UP MENU.
2. Display the D4 menu on the LCD by pressing the appropriate cursor buttons.
3. Press the [F1] button.
SET UP MENU appears on the monitor screen.
4. To close the SET UP MENU, press the [F4] button.

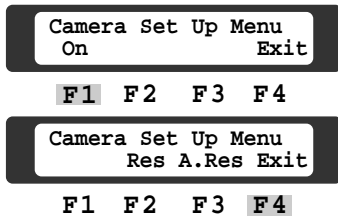

WV-CU360CJ

Press the CAM SETUP key while holding down the SHIFT key to open the SETUP menu.

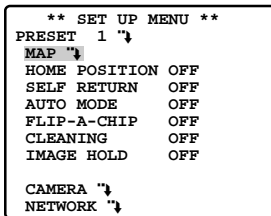

WV-CU161C

Press the CAMERA SETUP key for 2 seconds or more to open the SETUP menu.

WV-RM70

1. Turn the MODE SELECTION switch to NORMAL or ALARM OFF.
2. Press the PROG switch for 2 seconds or more to open the Program Menu.
3. Move the cursor to Camera Set Up Menu, and press the SET switch to open the SETUP MENU.

● Submenu Display

The items marked "↓" can be selected/changed on the submenu.

- Move the cursor to an item with the "↓" mark and press the CAM (SET) key. The submenu appears.

■ Presetting

● Preset Menu Display

1. Displaying the preset menu directly
 - (1) Move the cursor to PRESET 1 "↓" and select the position number by moving the joystick to the right or left.
 - (2) Press the CAM (SET) key.
The preset setting menu appears on the monitor screen.

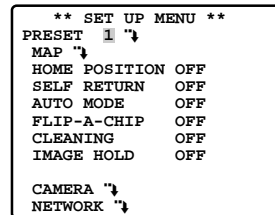

2. Displaying the preset menu from the PRESET NUMBER SET menu
 - (1) Move the cursor to MAP "↓" and press the CAM (SET) key.
The PRESET NUMBER SET menu appears on the monitor screen.
 - (2) Move the cursor to the position number to be set and press the CAM (SET) key.
The preset setting menu appears on the monitor screen.

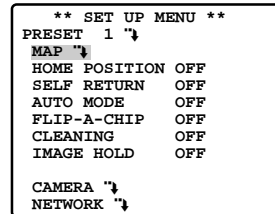

Notes:

- The * mark indicates that the position number has been preset.
- The character H refers to the home position.
- On the second bottom line, the preset ID appears respective to the selected number. "DOOR" next to "ID" in the example shown right is for preset position number 1.

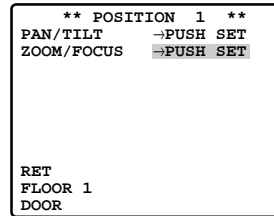
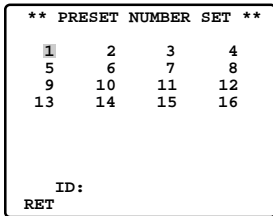

● Position Setting (POSITION SET)

Aligns the camera position and focal point by panning, tilting, zooming and focusing.

1. Move the cursor to POSITION SET on the preset setting menu and press the CAM (SET) key. The position setting menu appears.

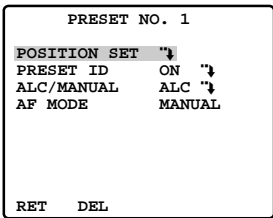

2. To Set Panning/Tilting Positions

- (1) Move the cursor to PUSH SET for PAN/TILT and press the CAM (SET) key. The PAN/TILT setting menu appears.
- (2) Select panning/tilting positions by moving the joystick up and down, right and left, and press the CAM (SET) key. The positions are set and the screen returns to the position setting menu.

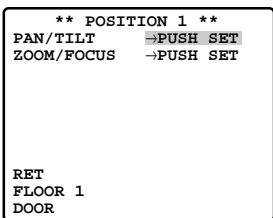

Note: When you press the CAM (SET) key, the camera might move slightly to memorize the nearest panning/tilting position.

3. To Set the Lens Zoom and Focus Positions

- (1) Move the cursor to PUSH SET for ZOOM/FOCUS and press the CAM (SET) key. The ZOOM/FOCUS setting menu appears.
- (2) Select a zoom position by moving the zoom control up and down, and a focus position by moving the focus control up and down, and then press the CAM (SET) key. The positions are set and the screen returns to the position setting menu.

Notes:

- When the camera is used at a nearly horizontal angle, the focus may not be adjustable to a high level of accuracy.
- If you move the cursor to the position number and move the joystick to the right or left, the position number can be selected. The selected preset position number can also be set after pressing the CAM (SET) key.
- The preset and camera IDs appear in the lower-left corner of the position setting menu after they have been set.
- With the WV-CU550CJ, you can also select a zoom position by moving the zoom wheel controller to the right or left.
- With the WV-CU550CJ, you can also select a focus position automatically by pressing the top button.

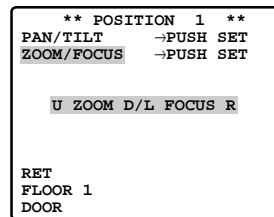

4. Move the cursor to RET and press the CAM (SET) key to return to the preset setting menu.

● Preset Identification Setting (PRESET ID)

Assigns a name to preset IDs (identification of up to 16 alphanumeric characters) and can be switched on or off on the monitor screen.

1. Move the cursor to PRESET ID on the preset setting menu and select ON or OFF by moving the joystick to the right or left.
The factory default setting is OFF.

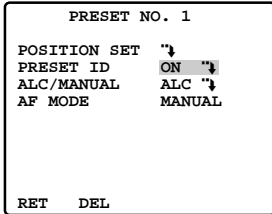

2. Press the CAM (SET) key to display the preset ID setting menu.

To Enter a New Preset ID

- (1) Move the cursor to the desired character using the joystick, and press the CAM (SET) key.
- (2) The selected character appears in the editing area. (The pointer in the editing area moves to the right automatically at this moment.) To enter a blank, select SPACE.
- (3) Repeat the above procedure until all characters are entered.

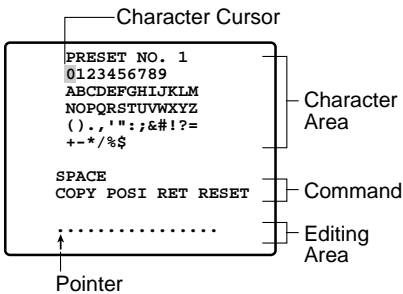

To Copy a Preset ID from Another Position

- (1) Move the cursor to COPY and press the CAM (SET) key. First the preset ID in the preceding position is shown. Each consecutive pressing of the CAM (SET) key displays the ID preceding the one currently displayed.
- (2) Display the desired ID.
- (3) Follow the step "To Change an Entered Preset ID" if necessary

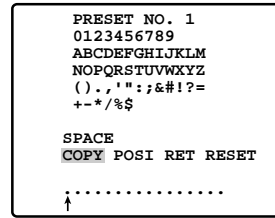

To Set a Display Position for a Preset ID

- (1) Move the cursor to POSI and press the CAM (SET) key. The display position set menu appears.
- (2) Move the ID to the desired position by using the joystick, and press the MON (ESC) key. The display position is set and the monitor screen returns to the preset ID setting menu.

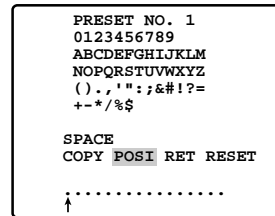

To Enter the Next ID without Returning to the Preset Setting Menu

- (1) In the preset ID setting menu, move the cursor to the top line and select a desired position number by moving the joystick to the right or left.
- (2) Enter, copy, change or delete the ID as described above.

To Return to the Preset Setting Menu

Move the cursor to RET and press the CAM (SET) key.

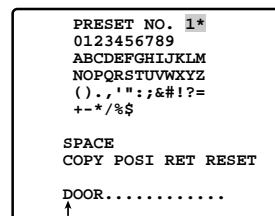

● Light Control Setting (ALC/MANUAL)

Selects the ALC or MANUAL mode for adjusting the lens iris.

- The factory default setting is ALC.
ALC: The lens iris is automatically adjusted to suit the brightness of the object.
MANUAL: The lens iris is fixed at the set value regardless of the brightness of the object.
- In case of ALC \rightarrow
 Press the CAM (SET) key. The backlight compensation menu appears on the monitor screen. See page 32 for the setting.

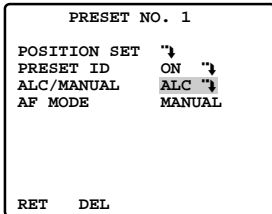

- In case of MANUAL \rightarrow
 Press the CAM (SET) key. The setting menu appears on the monitor screen. Set the lens iris level as desired by moving the joystick to the right or left.

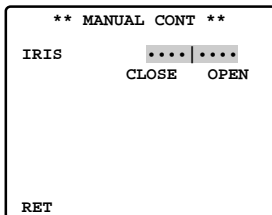

● Auto Focus Setting (AF MODE)

- The factory default setting is MANUAL.
MANUAL: AF does not work after moving to a preset position.
AUTO: AF works after moving to a preset position.

● To Return to the Preset Number Set Menu

- Move the cursor to RET and press the CAM (SET) key. The PRESET NUMBER SET menu appears with the * mark to the right of the preset position number.

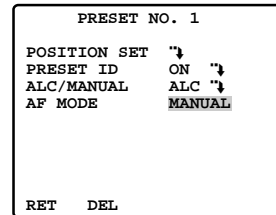

● To Return to the Setup Menu

- Move the cursor to RET and press the CAM (SET) key.

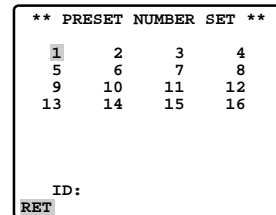

■ Deleting Preset Positions

- Move the cursor to PRESET 1 and select the position number to be deleted by using the joystick.

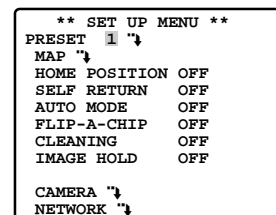

- Press the CAM (SET) key to display the preset setting menu.

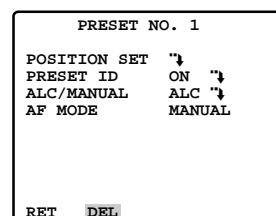

- Move the cursor to DEL and press the CAM (SET) key.

This deletes the preset position and the PRESET NUMBER SET menu appears. The * mark to the right of the number disappears.

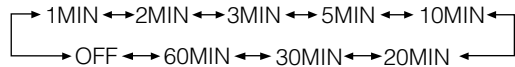
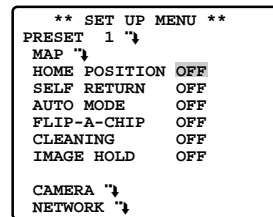
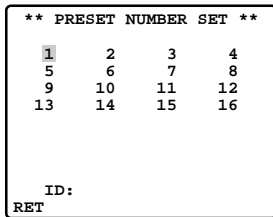

MIN stands for minute(s).

Note: The camera will return to the auto mode if that is set to AUTO PAN when a specific time has elapsed after a manual operation.

■ Home Position Setting (HOME POSITION)

The home position is the camera's basic position. It returns to this position automatically when a specific time has elapsed after a manual operation. This setting functions only when AUTO MODE is OFF.

- To set a position number for the home position
The factory default setting is OFF.

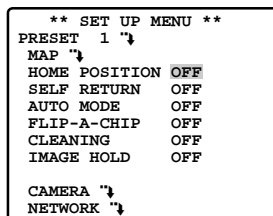

■ Auto Mode Selection (AUTO MODE)

AUTO MODE activates the camera's auto turn within the preset panning range.

- Auto mode

Move the cursor to AUTO MODE and select a mode by moving the joystick to the right or left.

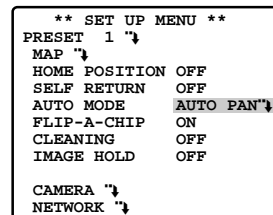

■ Self-return Setting (SELF RETURN)

Self-return is the time-out parameter for returning to the home position.

In ON position, the camera returns to AUTO MODE after a specific time following a manual operation.

To set a time-out parameter for return to the home position

- Move the cursor to SELF RETURN and select a return time by moving the joystick to the right or left.

The factory default setting is OFF.

Return time changes as follows:

The factory default setting is OFF.

Modes change as follows:

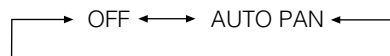

OFF: No automatic operation. The camera can be operated only manually.

AUTO PAN: You can activate the camera's auto turn within the preset panning range.

- When the AUTO PAN mode is selected, set details as follows:

Move the cursor to AUTO PAN and press the CAM (SET) key to display the AUTO PAN setting menu.

3. Panning starting point and panning endpoint

Follow the steps below.

- (1) Move the cursor to POSITION and press the CAM (SET) key. The cursor moves to START.

```

** AUTO PAN **
POSITION      START
              END
SPEED         .....|.....
              L           H
PAN LIMIT     OFF
ENDLESS       OFF
DWELL TIME    2S
RET
    
```

```

** AUTO PAN **
POSITION      START
              END
SPEED         .....|.....
              L           H
PAN LIMIT     OFF
ENDLESS       OFF
DWELL TIME    2S
RET
    
```

- (2) Move the joystick to the right or left to select a panning starting point and press the CAM (SET) key.

This determines the starting point and the cursor moves to END.

```

** AUTO PAN **
POSITION      START
              END
SPEED         .....|.....
              L           H
PAN LIMIT     OFF
ENDLESS       OFF
DWELL TIME    2S
RET
    
```

- (3) Move the joystick to the right or left to select a panning endpoint and press the CAM (SET) key.

This determines the endpoint, and the cursor moves to POSITION.

4. Panning speed

The panning speed increases when the joystick is moved to the right, and decreases when it is moved to the left.

```

** AUTO PAN **
POSITION      START
              END
SPEED         .....|.....
              L           H
PAN LIMIT     OFF
ENDLESS       OFF
DWELL TIME    2S
RET
    
```

Notes:

- If the panning range is changed after the camera has not panned for a long time or has been panning in the same panning range, the picture may not be clear or noise may appear. In this case, pan the camera fully several times. If this does not eliminate the problem, refer servicing to qualified service personnel.
- When you press the CAM (SET) key, the camera might move slightly to memorize the nearest panning/tilting position.

5. Pan limit ON/OFF

The factory default setting is OFF.

ON: Manual pan is limited from the starting point to the endpoint specified by position setting. Set ENDLESS to OFF before setting PAN LIMIT to ON.

OFF: Manual pan is not limited.

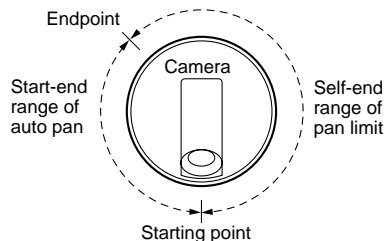

Note: When ON is selected for PAN LIMIT, manual pan moves the camera away from the other side (PAN LIMIT) of the start-end range.

6. ENDLESS to ON/OFF

The factory default setting is OFF.

ON: The camera pans from the starting point to the endpoint, and keeps rotating in the same direction to return to the starting point. Set PAN LIMIT to OFF before setting ENDLESS to ON.

```

** AUTO PAN **
POSITION      START
              END
SPEED         .....|.....
              L           H
PAN LIMIT     OFF
ENDLESS       ON
DWELL TIME    2S
RET
    
```

OFF: The camera pans from the starting point to the endpoint, and rotates backward to the starting point.

This movement is repeated over and over.

7. Dwell time

The factory default setting is 2S.

Dwell time changes as follows:

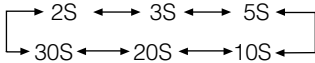

** AUTO PAN **	
POSITION	START
	END
SPEED
	L H
PAN LIMIT	OFF
ENDLESS	OFF
DWELL TIME	2S
RET	

Notes:

- When the panning or tilting in the AUTO PAN mode is controlled manually, the Auto mode function should be cancelled. To activate the auto mode, select the AUTO PAN mode again or set a time for SELF RETURN in the SET UP menu.
- Auto refreshing may be activated during the auto mode to calibrate the lens position.

■ Flip-A-Chip Setting

FLIP-A-CHIP is for setting the movement of the camera by using the joystick. The factory default setting is OFF.

** SET UP MENU **	
PRESET 1	↵
MAP	↵
HOME POSITION	OFF
SELF RETURN	OFF
AUTO MODE	OFF
FLIP-A-CHIP	OFF
CLEANING	OFF
IMAGE HOLD	OFF
CAMERA	↵
NETWORK	↵

OFF: Tilt range is limited to 0° to 92°.
ON: The flip-a-chip function allows the tilt angle to widen up to 180°.

Note: Flip-a-chip does not work if PAN LIMIT is set to ON.

■ Cleaning (CLEANING)

CLEANING is used for refreshing the electro-mechanical contacts built into the camera. Use this function for maintenance when the camera has been directed at a specific spot or panned over a specific range for a long time.

Built-in electric mechanical contacts are refreshed at regular intervals (approx. 7 days) if CLEANING is set to ON.

A dry contact adversely affects picture quality and motor operation.

** SET UP MENU **	
PRESET 1	↵
MAP	↵
HOME POSITION	OFF
SELF RETURN	OFF
AUTO MODE	OFF
FLIP-A-CHIP	OFF
CLEANING	ON
IMAGE HOLD	OFF
CAMERA	↵
NETWORK	↵

The factory default setting is OFF.

ON: The contacts are cleaned for approx. 1 minute. "CLEANING" disappears when the process is completed.



OFF: No contact cleaning
Note: Select OFF when the camera downloads or uploads preset data.

■ Image Hold (IMAGE HOLD)

The camera picture remains as a still image on the monitor screen until the camera reaches the preset position. The factory default setting is OFF.

** SET UP MENU **	
PRESET 1	↵
MAP	↵
HOME POSITION	OFF
SELF RETURN	OFF
AUTO MODE	OFF
FLIP-A-CHIP	OFF
CLEANING	OFF
IMAGE HOLD	ON
CAMERA	↵
NETWORK	↵

■ Camera Setting

To Display the Camera Setting Menu

Move the cursor to CAMERA "↓", and press the CAM (SET) key. The camera setting menu appears.

```

** SET UP MENU **
PRESET 1 "↓
MAP "↓
HOME POSITION OFF
SELF RETURN OFF
AUTO MODE OFF
FLIP-A-CHIP ON
CLEANING OFF
IMAGE HOLD OFF

CAMERA "↓
NETWORK "↓
    
```

```

** SET UP **
CAMERA ID ON "↓
ALC/MANUAL ALC "↓
SHUTTER OFF
AGC ON(MID)
SYNC INT
WHITE BAL ATW "↓
AF MODE MANUAL
EL-ZOOM ON
SENS UP OFF
MOTION DET OFF
RET SPECIAL "↓
    
```

● Camera Identification (CAMERA ID)

You can use the camera identification to assign a name to the camera. The camera ID consists of up to 16 alphanumeric characters. You can select whether to have the camera ID displayed on the monitor screen or not.

```

** SET UP **
CAMERA ID ON "↓
ALC/MANUAL ALC "↓
SHUTTER OFF
AGC ON(MID)
SYNC INT
WHITE BAL ATW "↓
AF MODE MANUAL
EL-ZOOM ON
SENS UP OFF
MOTION DET OFF
RET SPECIAL "↓
    
```

The factory default setting is OFF.

ON: Camera ID appears on the monitor screen.

OFF: Camera ID does not appear.

Press the CAM (SET) key to display the camera ID setting menu.

To Enter a New Camera ID

- (1) Move the cursor to the desired character using the joystick, and press the CAM (SET) key.
- (2) The selected character appears in the editing area. (The pointer in the editing area moves to the right automatically at this moment.) To enter a blank, select SPACE.
- (3) Repeat the above procedure until all characters are entered.

Note: Refer to page 27 for POSI, RET and RESET.

```

CAMERA ID --
0123456789
ABCDEFGHIJKLMN
OPQRSTUVWXYZ
( ) , ' " : ; & # ! ? =
+ - * / % $

SPACE
---- POSI RET RESET

↑ .....
    
```

● Light Control Setting (ALC/MANUAL)

You can select the mode for adjusting the lens iris. There are two modes as follows:

ALC: The lens iris is automatically adjusted to suit the brightness of the object.

You can select one of two modes (BLC ON or BLC OFF) of backlight compensation.

Backlight compensation is available in the ALC mode. It eliminates strong background light which makes the camera picture dark such as a spotlight.

MANUAL: The lens iris is fixed at the value that you have set regardless of the brightness of an object.

1. Display the SET UP menu on the monitor screen by referring to page 24.

```

** SET UP **
CAMERA ID ON "↓
ALC/MANUAL ALC "↓
SHUTTER OFF
AGC ON(MID)
SYNC INT
WHITE BAL ATW "↓
AF MODE MANUAL
EL-ZOOM ON
SENS UP OFF
MOTION DET OFF
RET SPECIAL "↓
    
```

2. The factory default setting is ALC. When you select ALC, set backlight compensation.

Note: The backlight compensation submenu associated with this menu is described separately and should be set up after installing the camera at the site and observing the actual site picture.

3. When MANUAL is selected, quit the setup menu by pressing the MON (ESC) key. Press the OPEN or CLOSE key on the controller for iris adjustment.

(1) ALC Mode with BLC ON

In normal use, the important object in a scene is placed in the centre of the monitor screen. When set at the factory, more photometric weight is given to the centre of the screen than to the edge of the screen (where bright backlight would most likely be located). In such a case, the object at the centre of the screen can be still clearly seen even though the backlight may vary.

1. Press the CAM (SET) key after selecting ALC. The ALC CONT menu appears.
2. Move the cursor to the BLC and select ON.

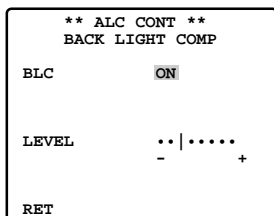
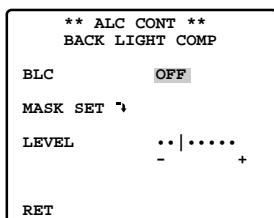

3. If you want to adjust the video output level, move the "I" cursor for LEVEL. Adjust it to the desired level by using the joystick.
4. Move the cursor to RET and press the CAM (SET) key to return to the CAM SET UP menu. To return to the camera picture, press the [F4] button.

(2) ALC Mode with BLC OFF

This mode is effective when the main object in the scene is not located in the centre of the screen but a source of bright light is located near the centre of the scene. In this mode, the picture is divided into 48 areas that mask the light to keep the clarity of the picture.

Note: The result of field setup of the mask area and level adjustment is fed back (effected) to the lens iris control in ALC mode.

1. Move the cursor to the BLC and select OFF. When you select MANUAL, BLC is not available. MASK SET appears on the menu.

2. Move the cursor to MASK SET and press the CAM (SET) key. The 48 mask areas appear on the monitor screen. The cursor is blinking in the top left corner of the screen.

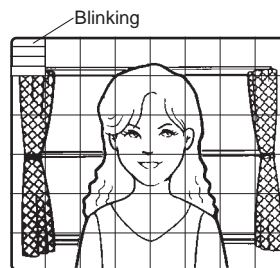

3. To mask an area where backlight is bright, move the cursor to the area and press the CAM (SET) key. The mask turns to white. Repeat this procedure to mask the desired area.

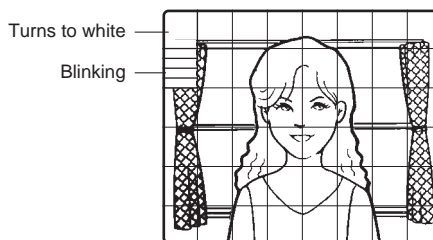
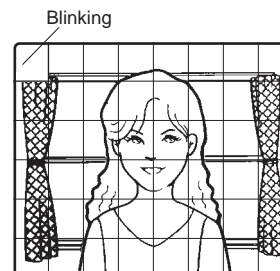

4. To cancel a masked area, move the cursor to the area, and press the CAM (SET) key. To cancel all masked areas, press the [F2] button of the WV-CU550CJ. For the WV-RM70, press the right and left switches simultaneously.
5. After masking is completed, press the MON (ESC) key. The 48 mask areas on the monitor screen disappear and the ALC CONT menu appears.

- If you want to change the video output level (picture contrast), move the "I" cursor for LEVEL and adjust the level.

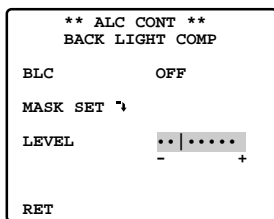

- Move the cursor to RET and press the CAM (SET) key to return to the CAM SET UP menu. To return to the camera picture, press the [F4] button.

● Shutter Speed Setting (SHUTTER)

You can select a shutter speed from among 1/60 (OFF), 1/100, 1/250, 1/500, 1/1000, 1/2000, 1/4 000, and 1/10 000 seconds. The factory default setting is OFF.

The electronic shutter speed changes as follows by using the joystick:

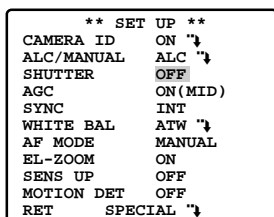
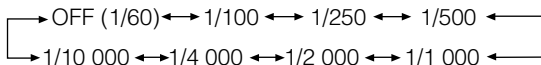

● Gain Control (AGC)

You can set the gain (brightness level portion of an image) to automatic level adjustment ON (LOW, MID, HIGH) or fixed level (OFF).

The factory default setting is ON (MID).

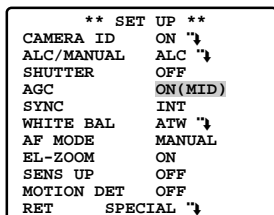

Note: For more information, refer to Digital Noise Reduction on page 38.

● Synchronization (SYNC)

You can select the internal sync (INT) mode or the line-lock sync (LL) mode. Additionally, this model accepts the VD2 signal (vertical drive signal multiplexed with the composite video output signal) from a specified component. Whenever the VD2 signal is supplied to this camera, the camera automatically switches to the VD2 sync mode.

When you select the line-lock sync (LL) mode, you can adjust vertical phase.

The factory default setting is INT.

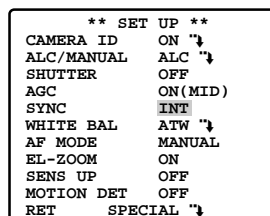

Important Notices:

- The priority of sync modes is given as follows:
 - Multiplexed vertical drive (VD2) (highest priority)
 - Line-lock (LL)
 - Internal sync (INT) (lowest priority)
- Whenever the vertical drive pulse (VD2) is supplied to the camera, the camera sync mode is automatically switched to the multiplexed vertical drive pulse (VD2) regardless of the selected sync mode.

Line-lock Sync Mode (LL)

- Move the cursor to SYNC and select LL by using the joystick. LL sync mode is not available when the multiplexed vertical drive (VD2) pulse is supplied.

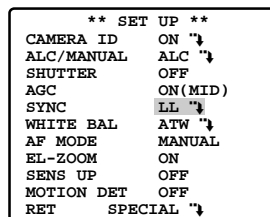

- After selecting LL, press the CAM (SET) key. The SYNC menu appears on the monitor screen.
- Supply the video output signal of the camera to be adjusted and the reference video output signal (for example, Camera 1) to a dual-trace oscilloscope.
- Set the dual-trace oscilloscope to the vertical rate and expand the vertical sync portion on the oscilloscope.

5. Move the cursor to COARSE by using the joystick.

```

** SYNC **
V PHASE
COARSE  1(1--16)
FINE    .|.....+
-
RET

```

6. Match the vertical phases for both video output signals as closely as possible by using the joystick. The coarse adjustment can be incremented in steps of 22.5 degrees (16 steps) with the joystick.

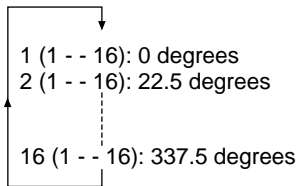

Note: After the 16 steps, the adjustment returns to the first step.

7. Move the cursor to FINE by using the joystick.
8. Use the joystick to match the vertical phase for both video output signals as closely as possible.

```

** SYNC **
V PHASE
COARSE  4(1--16)
FINE    .....|..+
-
RET

```

```

** SYNC **
V PHASE
COARSE  1(1--16)
FINE    .|.....+
-
RET

```

● White Balance (WHITE BAL)

(1) Auto-Tracing White Balance Mode (ATW)

In this mode, the color temperature is monitored continuously and thereby white balance is set automatically. The color temperature range for the proper white balance is approx. 2 600 to 6 000 K. Proper white balance may not be obtained under the following conditions:

1. The color temperature is out of the 2 600 to 6 000 K range.
2. When the scene contains mostly high color temperature (bluish) objects, such as a blue sky.
3. When the scene is dim.

In these cases, select the AWC mode.

1. Move the cursor to WHITE BAL and select ATW by using the joystick.
 The factory default setting is ATW.
 The white balance of the camera is automatically set.

```

** SET UP MENU **
PRESET  1 ↵
MAP     ↵
HOME POSITION OFF
SELF RETURN OFF
AUTO MODE OFF
FLIP-A-CHIP ON
CLEANING  OFF
IMAGE HOLD OFF

CAMERA  ↵
NETWORK ↵

```

Notes:

- When the "I" cursor reaches the "+" end, it jumps back to "-". At the same time, COARSE is incremented by one step to enable a continuous adjustment. The reverse takes place when the "I" cursor reaches the "-" end.
- When the joystick is kept at the right or left for one second or more, the "I" cursor moves quickly.
- To reset COARSE and FINE to the preset values, press the [F2] button of the WV-CU550CJ. For the WV-RM70, press the Right and Left switches simultaneously. COARSE is preset to zero-cross of the AC line phase.
- If the AC line contains noise (spike noise, etc.), the stability of the vertical phase of the camera video output signal may be disturbed.

```

** SET UP **
CAMERA ID  ON  ↵
ALC/MANUAL ALC  ↵
SHUTTER    OFF
AGC         ON(MID)
SYNC       INT
WHITE BAL  ATW  ↵
AF MODE    MANUAL
EL-ZOOM    ON
SENS UP    OFF
MOTION DET OFF
RET        SPECIAL ↵

```

- For fine adjustment of the ATW, press the CAM (SET) key. The ATW fine adjustment menu appears on the monitor screen.

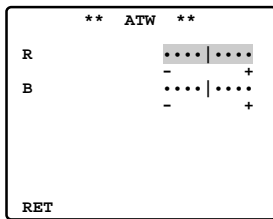

- Move the cursor to RET by using the joystick and press the CAM (SET) key to return to the SET UP menu.

(2) Automatic White Balance Control Mode (AWC)

- Move the cursor to WHITE BAL and select AWC → PUSH SET by using the joystick.

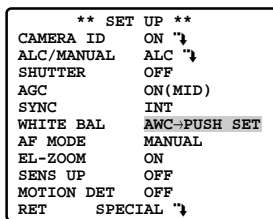

- Press the CAM (SET) key to start the white balance setup. PUSH SW is highlighted to indicate that white balance is being set.
- PUSH SW returns to normal when balance setting is completed.
- For fine adjustment of the AWC, move the cursor to AWC and press the CAM (SET) key. The AWC fine adjustment menu appears on the monitor screen.

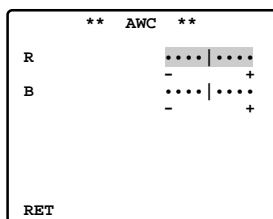

- Move the cursor to RET by using the joystick and press the CAM (SET) key to return to the SET UP menu.

● Auto Focus Setting (AF MODE)

The camera adjusts the focus automatically by sensing the centre of the picture.

MANUAL: Auto-focus is activated only when the AF key on the controller is pressed.

AUTO: Auto-focus is activated automatically while a manual pan, tilt or zoom operation is performed. The factory default setting is AUTO.

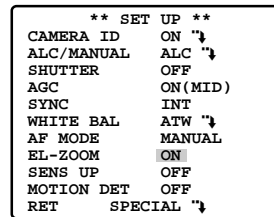

Note:

The auto focus lens may not function properly in the AUTO mode under the following conditions.

- Dirt or water on window glass
The auto focus may focus on the dirt or water.
- Low lighting or illumination
- Bright objects or high intensity objects
- Single color object such as a white wall or fine felt
- No centre objects and sloping objects
- Far and near objects on the screen

● Electronic Zoom (EL-ZOOM)

The electronic zoom magnifies a scene 5 times. With a 10-time optical zoom lens, the camera is capable of 50-time zoom.

- Move the cursor to EL-ZOOM and select ON or OFF by moving the joystick to the right or left, and then press the CAM (SET) key. The factory default setting is ON.

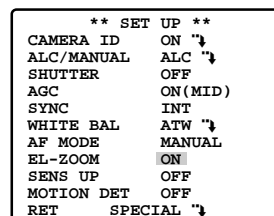

ON: 5-time electronic zoom is available with the ZOOM switch on the controller.

OFF: The electronic zoom function is not used.

Notes:

- A scene magnified by the electronic zoom function may be inferior in picture quality to a non-magnified one.
- The electronic zoom does not function in the preset position setting mode.
- To set preset positions directly from the WV-CU550CJ, WV-CU360CJ or WV-CU161 System Controller, you need to set the electronic zoom function temporarily to OFF.

● Electronic Sensitivity Enhancement (SENS UP)

1. Move the cursor to SENS UP and select the desired electronic sensitivity enhancement mode by using the joystick.
The factory default setting is OFF.

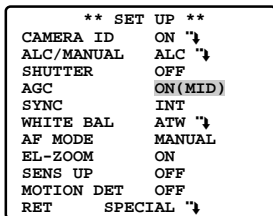

The electronic sensitivity enhancement mode changes as follows by operating the joystick:

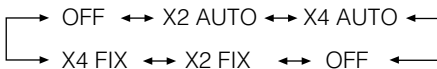

Note: While the SENS UP function is selected, noise or spots may appear in the picture when the sensitivity of the camera is increased. This is a normal phenomenon.

● Motion Detector (MOTION DET)

1. Move the cursor to MOTION DET and select ON or OFF by using the joystick.
The factory default setting is OFF.
2. If ON is selected, press the CAM (SET) key.
The MOTION DETECT menu appears.

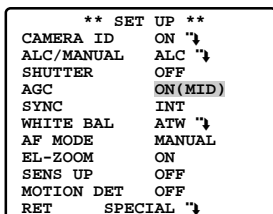

You can mask the areas in this menu.

3. Move the cursor to MASK SET and press the CAM (SET) key.
48 mask areas appear on the monitor screen.
Refer to the Light Control Setting on page 33 for masking operations.
4. After masking areas, press the MON (ESC) key.
The MOTION DETECT menu appears on the monitor screen.

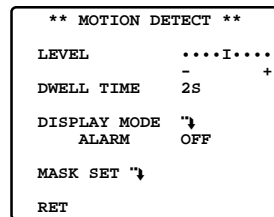

5. Move the cursor to ALARM and select ON or OFF by using the joystick.
The factory default setting is OFF.
ON: The alarm signal is supplied while the display mode is activated.
OFF: The alarm signal is not supplied while the display mode is activated.
6. Move the cursor to DISPLAY MODE.
Press the CAM (SET) key to see the present setting. The areas that detect motion blink.

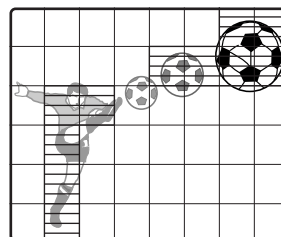
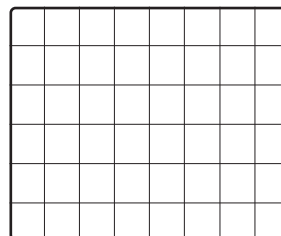

7. Move the cursor to LEVEL by using the joystick.
Obtain the optimum detection level by moving the joystick to the right or left.

Note: Repeat the above procedures until you obtain the adjusted results.

8. Dwell Time

Move the cursor to DWELL TIME, and select a time with the Joystick.

When the time specified here elapses after motion detection, the camera will notify the connected device of the alarm activation. The default setting is 2 seconds.

Selectable times (seconds): 2s, 5s, 10s, 30s

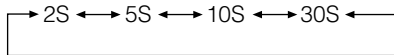

Important Notices:

- The following conditions should be met for motion detection.
 - The picture size on the screen should be larger than 1/48 of the actual picture size.
 - The contrast ratio between the object and the background picture should be more than 5 % at the maximum detection level.
 - The time it takes the object to move from one end of the screen to the other should be more than 0.1 seconds.
- Also under the following conditions, mask or adjust the detection level to prevent malfunction.
 - When leaves, or curtains, etc., are swayed by the wind.
 - When a picture has a high noise content due to low light conditions.
 - When the object is illuminated by lighting equipment that constantly turns on and off.

● Special Menu (SPECIAL)

This menu allows you to adjust and set up the following items and functions: chroma level, aperture level, pedestal level, demo mode function, digital noise reduction function and refresh function.

You can also reset your parameters to the values preset at the factory.

This menu lets you adjust and set up the picture quality to meet your requirements.

- Move the cursor to SPECIAL and press the [F2] button of the WV-CU550CJ. The special menu appears on the monitor screen. For the WV-RM70, keep pressing the Right and Left switches simultaneously for 2 seconds or more.

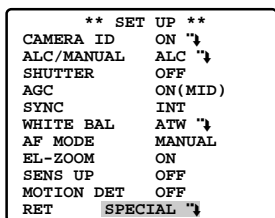

(1) Chroma Level Setting (CHROMA GAIN)

(2) Aperture Level Setting (AP GAIN)

(3) Pedestal Level Setting (PEDESTAL)

(4) Camera Phase (Hue) Setting (HUE)

- Move the cursor to HUE. The "I" cursor appears in inverse video.
- While observing the vector scope or color video monitor, adjust the chroma phase (hue) by using the joystick. The cursor moves to the right or left. To reset to the factory setup, press the [F2] button of the WV-CU550CJ. (For the WV-RM70, keep pressing the Right and Left switches simultaneously for 2 seconds or more.)

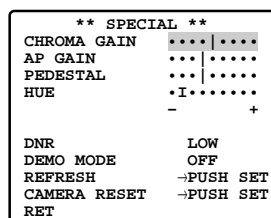

(5) Digital Noise Reduction (DNR)

DNR may be used to improve quality under low light conditions.

LOW: DNR level is low.

HIGH: DNR level is high.

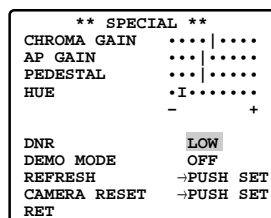

(6) Demonstration Display (DEMO MODE)

You can output the upside-down image by using Demo Mode.

Note: Never face the camera at a place exposed to strong light sources for a long time. If light sources such as spot light cause burn-in on the display screen, part of image may discolor due to deterioration of the color filter in the CCD when changing the aim of the camera etc.

(7) To Restore the Camera Default Position (REFRESH)

Move the cursor to REFRESH by using the joystick and press the [F2] button of the WV-CU550CJ. For the WV-RM70, WV-CU360CJ or WV-CU161C, keep pressing the Right and Left switches simultaneously for 2 seconds or more.

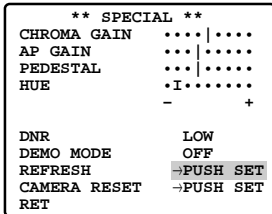

Reset to the Factory Default Settings

Any of the above settings plus the ALC/MANUAL level control and phase adjustments can be reset to the factory default settings by placing the cursor over the desired mode and then pressing the [F2] button of the WV-CU550CJ. For the WV-RM70, keep pressing the Right and Left switches simultaneously for 2 seconds or more.

(8) Camera Resetting (CAMERA RESET)

Move the cursor to CAMERA RESET by using the joystick and press the [F3] button of the WV-CU550CJ.

The camera is reset to the factory settings.

For the WV-RM70, keep pressing the Right, Left and Set switches simultaneously for 2 seconds or more. For the WV-CU360CJ or WV-CU161C, keep pressing the Right and Left switches and the numeric button 5 simultaneously for 2 seconds or more.

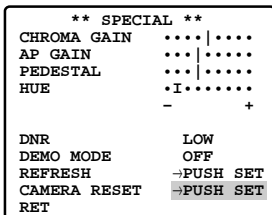

(9) To Close the SPECIAL Menu

Move the cursor to RET and press the CAM (SET) key.

The setup menu appears on the monitor screen.

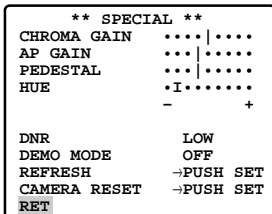

INITIALIZING

You can reset the following data to the factory default settings.





- Camera Setup
- HTML files

Setting the Switches

The camera is provided with an 8-bit DIP switch. The 8-bit DIP switch is used to return the camera to the factory default settings. Switch settings are read into the camera when the power is turned on. Make sure to turn the camera off, then turn it back on after changing the switch settings. Switch positions and functions are shown below.

Note: All DIP switches except SW1 and SW2 should always be set to "off".

- Menus:** Initializing Setup menu
Initializing HTML files
Initializing Setup menu and HTML files

No.	DIP SW1	DIP SW2	Status	Dip SW Position
1	OFF	OFF	Normal	
2	ON	OFF	Initializing the setup menu	
3	OFF	ON	Initializing HTML files	
4	ON	ON	Initializing the setup menu & HTML files	

Common procedures:

1. Set DIP SW1 and SW2 in accordance with the table.
2. Turn the power on, and wait until the servo initialization of Camera is completed.
3. Turn the power off, and return the DIP switch to normal position.

Note: Do not make any DIP switch setting other than above.

TROUBLESHOOTING

Symptom	What to do	Reference page
No picture is displayed.	<ul style="list-style-type: none"> • Is the AC adapter firmly plugged in to the outlet? • Are the POWER IN terminals on the camera connected with the AC adapter properly? • Is the video cable or network cable connected properly? 	8, 12
Cannot access the camera from the browser.	<ul style="list-style-type: none"> • Are the network cables connected properly? • Is the status indicator lamp of the network connection terminal on? If not, a network connection has not been established or the other devices are not in operation. • Is a valid IP address set for the camera? • Are you connecting to a wrong IP address? Open the command prompt on your PC and enter: >ping (enter here the IP address set for the camera). If the camera replies, the connection is correct. If not, set the correct IP address for your PC and/or to the camera. 	16
HTML documents are not displayed.	<ul style="list-style-type: none"> • HTML files in the camera might be broken. Initializing is required. 	46

PREVENTION OF BLOOMING AND SMEAR

When the camera is aimed at a bright light, such as a spotlight, or a surface that reflects bright light, smear or blooming may appear. Therefore, the camera should be operated carefully in the vicinity of extremely bright objects to avoid smear or blooming.

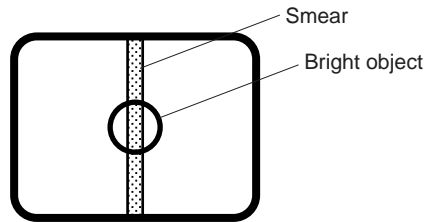

SPECIFICATIONS

Network Section	
Image resolution	640x480, 640x240, 320x240, 160x120 pixel
Image process	JPEG (Super Fine/Fine/Normal/Low image quality selectable)
Image refreshing rate	Fast/Middle/Slow/Very Slow
Traffic control	32 kbps, 64 kbps, 128 kbps, 256 kbps, 512 kbps, 1 024 kbps, Unlimited
Protocols supported	TCP/IP, UDP/IP, HTTP, FTP, SMTP, DNS, DDNS, DHCP, ARP, BOOTP, NTP
OS applicable	Windows 98 SE, Windows NT WORKSTATION 4.0 Service Pack6a, Windows 2000 Professional Service Pack2, Windows ME, or Windows XP
Applicable browsers	Internet Explorer 5.01 SP2, 5.5, 5.5 SP2, 6.0, or Netscape Communicator 4.73, 4.78

Camera Section	
Effective pixels	768 (H) x 494 (V)
Scanning area	3.65 mm (H) x 2.71 mm (V), 1/4"
Synchronization	internal/line-lock / multiplexed vertical drive (VD2)
Horizontal scanning frequency	15.734 kHz
Vertical scanning frequency	59.94 Hz
Video output	1.0 V[p-p] NTSC composite/75 Ω
Horizontal resolution	more than 480 lines at center
Vertical resolution	more than 350 lines at center
Signal-to-noise ratio	50 dB (AGC OFF, weight on)
Minimum illumination	1.0 lx (0.1 foot-candle) (AGC ON HIGH)
Auto focus	MANUAL/AUTO
Auto mode	OFF/AUTO PAN
Flip-A-chip	ON/OFF
Camera ID	preset ID, camera ID, characters
MOTION DET	ON/OFF
ALARM IN	2 INPUT (ALARM IN 1-2), Low-active
ALARM OUT, AUX OUT	16 V DC 100 mA, Low-active
Cleaning	ON/OFF
Electronic shutter	1/60 (OFF), 1/100, 1/250, 1/500, 1/1 000, 1/2 000, 1/4 000, 1/10 000 s
AGC	ON (LOW)/ON (MID)/ON (HIGH)/OFF
SENS UP	max. 4 times, AUTO/FIX
BLC	ON/OFF (SETUP MENU) selectable

Lens/Mechanism sections		
Iris	automatic (open/close is possible)/manual	
Zoom ratio	x10 + digital zoom x 5	
Maximum aperture ratio	1 : 1.4 (WIDE) to 2.0 (TELE)	
Focal length	4.2 to 42 mm	
Angular field of view	H	4.9° to 48°
	V	3.7° to 36°
Zoom speed	approx. 3.8 s (TELE/WIDE) in manual mode	
Focus speed	approx. 3.0 s (FAR/NEAR) in manual mode	
Panning range	360° endless	
Panning angle setting	possible (in auto-pan mode)	
Panning mode	manual/auto pan	
Panning speed	manual : approx. 1.0 °/s to 100 °/s, 8-steps/64-steps preset position : maximum approx. 100 °/s	
Tilting range	0° to 92°	
Tilting mode	manual	
Tilting speed	manual : approx. 1.0 °/s to 100 °/s, 8-steps/64-steps preset position : maximum approx. 100 °/s	
Controls	pan/tilt, lens, 16 preset positions, home position	

Power source	24 V AC, 60 Hz
Power consumption	15 W
Ambient operating temperature	-10 °C to +50 °C (14 °F to 122 °F)
Dimensions	120 (D) x 196 (H) mm (4-3/4" (D) x 7-3/4" (H))
Weight	approx. 1.5 kg (3.3 lbs)

Weights and dimensions indicated are approximate.
Specifications are subject to change without notice.

ACCESSORIES

Decoration cover	1 pc.
Connector for 24 V AC	1 pc.
RJ-45 female-female conversion connector	1 pc.
CD-ROM (PDF Manual Contained)	1 pc.
MAC Code Label	1 pc.

OPTIONAL ACCESSORIES

Dome cover (approx. 60 % smoked type)	WV-CS2SE
Dome cover (approx. 50 % smoked type)	WV-CS2SHE
Dome cover (approx. 70 % metal type)	WV-CS2ME
Ceiling mounting bracket	WV-Q105/WV-Q106/WV-Q107A
Wall mounting bracket	WV-Q108A

APPENDIX

Shortcuts

Shortcut operations are available to controllers having the CAM FUNCTION key. Entering from one to three digits using the numeric key(s) and pressing the CAM FUNCTION key will create a shortcut to the respective functions. The CAM FUNCTION key is abbreviated as [CAM FUNC] in the table below.

Function	Key	Function	Key
Selecting a PRESET position From #1 to #16		Memorize PRESET	From #1 to #16
#1	[1] + [CAM FUNC]	Position #1	[1] + [0] + [1] + [CAM FUNC]
#16	[1] + [6] + [CAM FUNC]	Position #16	[1] + [1] + [6] + [CAM FUNC]
AUTO PAN		IRIS	
ON	[6] + [5] + [CAM FUNC]	Open	[1] + [6] + [9] + [CAM FUNC]
OFF	[6] + [6] + [CAM FUNC]	Close	[1] + [7] + [0] + [CAM FUNC]
Speed Up	[6] + [7] + [CAM FUNC]	EL-SHUTTER	
Speed Down	[6] + [8] + [CAM FUNC]	On	[1] + [7] + [1] + [CAM FUNC]
Setting Start Point	[6] + [9] + [CAM FUNC]	Off	[1] + [7] + [2] + [CAM FUNC]
Setting End Point	[7] + [0] + [CAM FUNC]	Speed Up	[1] + [7] + [3] + [CAM FUNC]
Setting PAN Reverse	[7] + [4] + [CAM FUNC]	Speed Down	[1] + [7] + [4] + [CAM FUNC]
ENDLESS PAN		AGC	
On	[7] + [6] + [CAM FUNC]	On	[1] + [7] + [5] + [CAM FUNC]
Off	[7] + [7] + [CAM FUNC]	Off	[1] + [7] + [6] + [CAM FUNC]
BLC		SENS UP	
On	[8] + [4] + [CAM FUNC]	On	[1] + [7] + [7] + [CAM FUNC]
Off	[8] + [5] + [CAM FUNC]	Off	[1] + [7] + [8] + [CAM FUNC]
AUTO FOCUS		Up	[1] + [7] + [9] + [CAM FUNC]
AUTO	[8] + [6] + [CAM FUNC]	Down	[1] + [8] + [0] + [CAM FUNC]
MANUAL	[8] + [7] + [CAM FUNC]	SENS UP AUTO	
AF On (Activate)	[8] + [8] + [CAM FUNC]	On	[1] + [8] + [1] + [CAM FUNC]
HOME POSITION		Off	[1] + [8] + [2] + [CAM FUNC]
Move to HOME	[8] + [9] + [CAM FUNC]	Up	[1] + [8] + [3] + [CAM FUNC]
CAMERA ID		Down	[1] + [8] + [4] + [CAM FUNC]
On	[9] + [3] + [CAM FUNC]	LL SYNC phase	
Off	[9] + [4] + [CAM FUNC]	INC	[1] + [8] + [5] + [CAM FUNC]
EL-ZOOM		DEC	[1] + [8] + [6] + [CAM FUNC]
On	[9] + [8] + [CAM FUNC]	PAN	
Off	[9] + [9] + [CAM FUNC]	180° turn	[1] + [8] + [7] + [CAM FUNC]
RESTART		CLEANING	
Begin	[1] + [0] + [0] + [CAM FUNC]	On	[1] + [8] + [8] + [CAM FUNC]
		Off	[1] + [8] + [9] + [CAM FUNC]

Notes:

- Actual operation takes place when the conditions for the changed settings are met.
- Shortcuts may be ignored while PAN/TILT, ZOOM or FOCUS is in operation.

Panasonic Digital Communications & Security Company
Unit of Matsushita Electric Corporation of America

Security Systems Group

www.panasonic.com/cctv

Executive Office: One Panasonic Way 3E-7, Secaucus, New Jersey 07094

Zone Office

Eastern: One Panasonic Way, Secaucus, NJ 07094 (201) 348-7303

Central: 1707 N.Randal Road, Elgin, IL 60123 (847) 468-5205

Western: 6550 Katella Ave., Cypress, CA 90630 (714) 373-7840

PANASONIC CANADA INC.

5770 Ambler Drive, Mississauga,
Ontario, L4W 2T3 Canada (905)624-5010

PANASONIC SALES COMPANY

DIVISION OF MATSUSHITA ELECTRIC OF PUERTO RICO INC.

San Gabriel Industrial Park 65th Infantry Ave. KM. 9.5 Carolina,
P.R. 00985 (809)750-4300